



**kela<sup>+</sup>**

# *Themenwelt Küche*

Kitchen Concepts · Le monde de la Cuisine





# *Willkommen in der Themenwelt Küche*

Kela präsentiert ein abgerundetes und innovatives Markensortiment rund um die Küche. Hochwertiges Kochgeschirr, nützliche Küchenhelfer, attraktive Küchentextilien, ein abverkaufsstarkes Produktangebot zum Thema Kochen am Tisch und trendige Ideen zur Tischkultur.

Sichern Sie sich mit uns einen Vorsprung am Markt. Mit mehr als 1.800 Markenprodukten und erfolgreichen Verkaufskonzepten punktet Kela weltweit beim Handel und beim Endverbraucher.

Wir wünschen Ihnen viel Freude beim Stöbern in unserem neuen Küchen-Katalog.

## **Welcome to the world of kitchens**

Kela presents a rounded and innovative range of brand-name products for the kitchen. High-quality cookware, useful cooking utensils, attractive kitchen linens, a best-selling product range for cooking at the table and fashionable tableware ideas.

Gain a competitive edge on the market with Kela. With over 1800 brand-name products and successful sales concepts, Kela hits the mark with retailers and consumers worldwide.

We hope you enjoy browsing through our new catalogue.

## **Bienvenue dans le Monde Culinaire**

La marque Kela propose une gamme innovante et complète autour de la cuisine. Des accessoires de cuisson haut de gamme, des accessoires d'aide à la cuisson, du textile de cuisine, ainsi qu'une très large gamme dans le domaine de la cuisine conviviale « Cuisiner à Table ».

Avec plus de 1800 produits ainsi que de nombreux concepts adaptés à chaque surface de vente, Kela vous permet d'avoir un temps d'avance et se distingue dans le monde entier, chez les détaillants, ainsi qu'après du consommateur final.

Nous vous souhaitons beaucoup de plaisir en feuilletant notre nouveau catalogue.



**Kochgeschirr**

- Pfannen
- Kochgeschirr
- Zubehör
- Auflaufformen

**Cookware**

- Frying pans
- Cookware
- Accessories
- Baking dishes

**Accessoires de cuisson**

- Poêles
- Accessoires de Cuisson
- Accessoires
- Plats à four



**Vorbereiten**

- Verarbeitungsgeräte
- Backzubehör
- Schneiden / Schälen
- Salz-/Pfeffermühlen

**Préparation**

- Utensils
- Baking accessories
- Cutting / peeling
- Salt/pepper mills

**Préparer**

- Ustensiles pour préparation
- Accessoires à pâtisserie
- Couper/Eplucher
- Moulins à poivre/sel



**Servieren**

- Espressokannen
- Kaffeebereiter
- Milchaufschäumer
- Teekannen
- Wasserkessel
- Saftkrüge
- Drahtkörbe
- Käsehobel

**Serving**

- Espresso jugs
- Coffee makers
- Milk foamers
- Teapots
- Kettles
- Juice jugs
- Wire baskets
- Cheese graters

**Servir**

- Percolateurs
- Cafetières à piston
- Mousseurs lait
- Théières / Bouilloires
- Pichet à jus
- Corbeilles
- Girolles à fromage





75

**Kochen am Tisch**

- Elektrogeräte
- Fondues
- Heißer Stein
- Schokofondue
- Feuerzangenbowle
- Rechauds
- Zubehör

**Cooking at the table**

- Electrical appliances
- Fondues
- Hot stone
- Chocolate fondue
- Fire punch set
- Rechauds
- Accessories

**Cuisiner à Table**

- Appareils électriques
- Fondues
- Pierre chaude
- Fondues chocolat
- Set punch
- Réchauds
- Accessoires



94+125

**Ordnung**

- Vorratsbehälter
- Brotkästen
- Küchenrollenhalter
- Spülen
- Körbe
- Uhren
- Schirmständer
- Treteimer

**Tidies**

- Storage containers
- Bread baskets
- Kitchen roll holders
- Washing up
- Baskets
- Clocks
- Umbrella holders
- Dust bins

**Rangement**

- Contenants
- Boîtes à pain
- Porte Essuie-tout
- Accessoires d'évier
- Corbeilles
- Hologes
- Porte parapluie
- Poubelles à pédale



110

**Küchentextilien**

- Geschirrtücher
- Topflappen
- Topfhandschuhe
- Schürzen
- Tischsets
- Untersetzer

**Kitchen textiles**

- Dish towels
- Pot holders
- Oven gloves
- Aprons
- Place mats
- Coasters

**Textiles de cuisine**

- Torchons de cuisine
- Maniques
- Gants de cuisine
- Tabliers
- Sets de table
- Dessous de verre

Symbolerklärung auf Seite 137 / Explanation of symbols on the page 137 / Explication des symboles Page 137







# Kochen, braten und genießen

Mit fundiertem Know-how und der Begeisterung für schöne Produkte setzt Kela Maßstäbe in Sachen Qualität, Funktion und Design. Die Qualität beginnt mit der Auswahl der verwendeten Materialien, geht über verschiedene Prüfverfahren und endet bei der sorgfältigen Verarbeitung.

Um beste Koch- und Bratergebnisse zu erzielen, ist die passende Materialauswahl zum jeweiligen Gericht und zu den jeweiligen Anforderungen von großer Bedeutung.

## Beschichtungen

Kela verwendet nur hochwertige Antihaftbeschichtungen, die PFOA-frei sind. Die Kochgeschirre von Kela sind für alle Herdarten geeignet, auch für Induktion.

**You can never go wrong with Kela when it comes to cooking, frying and enjoying your food.**

Kela sets the standard in quality, functionality and design with its in-depth knowledge and expertise and an enthusiasm for beautiful products. Quality starts with the selection of the materials used, through different testing processes and ends with careful workmanship. The appropriate choice of material for each dish and for specific requirements is of great importance to achieve the very best cooking and frying results.

## Coatings

Kela only uses high-grade non-stick coatings that are PFOA-free throughout. Kela cookware is suitable for all types of cooker, including induction hobs.

**Cuisiner, braiser et déguster**

Par son savoir et son enthousiasme pour de beaux produits, Kela est très exigeant sur la qualité, la fonction et le design de ses collections. Le processus de fabrication commence par le choix du matériau adapté, suivi de tests très exigeants et se termine par une grande qualité de fabrication. Afin d'obtenir la cuisson la plus optimale possible, chaque matériau adapté à chaque type de cuisson a son importance.

## Revêtements

Kela n'utilise que des revêtements anti adhésif haut de gamme, sans PFOA. Les accessoires de cuisson KELA sont compatibles tous feux y compris induction.



**Gusseisen**  
**Cast iron**  
**Fonte**

- Schmoren und scharfes Anbraten**
- Einzigartige Wärmekapazität.
  - Gleichmäßige Wärmeverteilung und Wärmespeicherung aufgrund der Dicke des Materials.
  - Für hohe Temperaturen geeignet.

- Braising and searing**
- Extremely robust, tremendously good heat retention and heat distribution, withstands very high levels of heat. Saves time and energy.

- Mijoter et saisir à feu vif**
- Très robuste, excellente accumulation et répartition de la chaleur permettant des températures très élevées. Gain de temps et d'énergie.

**Eisen**  
**Iron**  
**Fer**

- Scharfes Anbraten**
- Sehr robust
  - Natürliche Antihafteffekt durch Einbrennen vor Gebrauch.
  - Ideal für schnelles Anbraten und Bräunen bei hohen Temperaturen.
  - Das Bratgut wird außen kross und innen saftig und zart.
  - Gute Wärmekapazität
  - Verträgt extrem hohe Hitze.

- Searing**
- Extremely robust, scratch-resistant, heats up quickly, withstands extremely high levels of heat and has excellent heat transfer. The patina, which forms gradually, is your guarantee for a unique frying and taste experience and provides a natural protective layer.

- Saisir à feu vif**
- Très robuste, résistant aux rayures, chauffe très rapidement, supporte des températures très élevées et assure une excellente répartition de la chaleur. La patine qui se forme peu à peu, garantit un plaisir exceptionnel aux amateurs de viande saisie et une couche de protection naturelle.

**Kupfer**  
**Copper**  
**Cuivre**

- Schnelles, gleichmäßiges Anbraten und Flambieren**
- Hohe Temperaturleitfähigkeit
  - Sehr gleichmäßige Wärmeverteilung
  - Reagiert schnell auf Temperaturveränderungen
  - Energieeffizient

- Fast and even searing and flambéing**
- Excellent heat distribution from the base to the pouring rim, therefore extremely energy-efficient and time-saving. Robust and durable.

- Pour saisir uniformément et pour flamber**
- Très bonne répartition de la chaleur depuis le fond jusqu'aux bords, d'où gain d'énergie et de temps. Robuste et une excellente durée de vie garantie.



# Materialkunde für Kochgeschirr

Cookware materials

Matériau Client pour accessoires de Cuisson

Edelstahl  
Stainless steel  
Inox

- Scharfes Anbraten und Kochen**
- Äußerst robust und nahezu unverwüstlich
  - Extreme Hitze oder Temperaturschock beim Ablöschen machen diesem Material nichts aus.
  - Pflegeleicht und brillant.

## Searing

Extremely tough and virtually indestructible to use. Stresses, like extreme heat or thermal shocks during quenching, are not a problem for this material. Easy-care and shiny.

## Saisir à feu vif

Extrêmement robuste et presque indestructible à l'usage. Les sollicitations extrêmes telles que de très hautes températures et même les chocs thermiques n'ont aucune action sur cette matière. D'entretien facile et brillant.

Aluguss  
Cast aluminium  
Fonte d'aluminium

- Schonendes und fettarmes Braten**
- Gute Wärmeaufnahme und optimale Wärmeverteilung.
  - Sehr energieeffizient.
  - Gesundes und fettfreies Braten möglich.

## For healthy and low-fat frying

Good heat absorption and optimum heat distribution, therefore extremely energy-efficient. The high-quality coating provides for healthy and fat-free frying.

## Une Cuisson saine et pauvre en matière grasse

Très bonne absorption et répartition optimale de la chaleur, d'où une excellente efficacité énergétique.

Aluminium  
Aluminium forged  
Aluminium forgé

- Schonendes und fettarmes Braten**
- Gute Wärmeaufnahme und optimale Wärmeverteilung.
  - Sehr energieeffizient.
  - Gesundes und fettfreies Braten möglich.

## For healthy and low-fat frying

Good heat absorption and optimum heat distribution, therefore extremely energy-efficient. The high-quality coating provides for healthy and fat-free frying.

## Une Cuisson saine et pauvre en matière grasse

Très bonne absorption et répartition optimale de la chaleur, d'où une excellente efficacité énergétique.



# Stella Nova

**Aluminium**  
Aluminium forged  
Aluminium forgé



**Die Vielfältige, mit rauher Oberfläche.**  
Für krosses und sanftes Braten.  
Das OIL CONTROL SYSTEM hält das Öl/Fett dort, wo es benötigt wird und spart dadurch Öl/Fett.  
Induktionsgeeignet.

**The versatile pot, with a rough surface.**  
For crispy and gentle frying.  
The OIL CONTROL SYSTEM keeps the oil/fat where it is needed, thereby saving oil/fat.  
Suitable for induction hobs.

**La polyvalente, avec revêtement alvéolé.**  
Pour un cuisson saine et douce.  
L'utilisation d'huile ou de matières grasses se limite au périmètre de cuisson, grâce au Système Oil Control, et permet une cuisson plus saine.  
Compatible induction.



**Zwei Auslassventile**  
Two outlet valves  
Deux soupapes vapeurs



**OIL CONTROL SYSTEM**

0-180°

**Softtouch-Griffe aus Bakelit**  
Soft-touch Bakelite handles  
Poignée Softtouch Bakélite

**Dickwandiges Aluminium**  
Thick-walled aluminium  
Paroi Aluminium épaisse

**Energiesparboden**  
Energy-saving base  
Socle à économie d'énergie



**OIL CONTROL SYSTEM**



**Robuste Antihafbeschichtung**  
Durable non-stick coating  
Revêtement anti adhésif robuste

**Dickwandiges Aluminium**  
Thick-walled aluminium  
Paroi Aluminium épaisse d'énergie

**Allherd- und Energiesparboden**  
Energy-saving base suitable for all cookers  
Tous feux- Socle à économie d'énergie

# Stella Nova



Bratpfanne 20 cm Ø  
Frying pan · Poêle

1 - 6

12215 4025457122156



Bratpfanne 24 cm Ø  
Frying pan · Poêle

1 - 6

12216 4025457122163



Bratpfanne 28 cm Ø  
Frying pan · Poêle

1 - 6

12217 4025457122170



Kochtopf 20 cm Ø 2,2 L  
Covered saucepot · Faitout

1 - 4

12218 4025457122187



Kochtopf 24 cm Ø 3,5 L  
Covered saucepot · Faitout

1 - 4

12219 4025457122194



Grill-Platte 29 x 23 cm  
Flat griddle pan · Planche à griller

1 - 4

12220 4025457122200

0-260°



## Spürbar anders!

- ✦ Kross & soft braten
- ✦ Gleichmäßige Ölverteilung durch OIL CONTROL SYSTEM
- ✦ Robuste Antihafbeschichtung
- ✦ Energiesparboden
- ✦ Ansprechendes Design

OIL CONTROL SYSTEM





# Kerros

Aluguss  
Cast aluminium  
Fonte d'aluminium

**Die Sanfte, mit glatter Oberfläche.**  
Ideal für fettarme oder fettlose Zubereitung.  
Außergewöhnliches Preis-/Leistungsverhältnis.  
Induktionsgeeignet.

**The gentle pot, with a smooth surface.**  
Ideal for low-fat or fat-free cooking.  
Exceptional value for money.  
Suitable for induction hobs.

**La douce Avec revêtement lisse.**  
Idéale pour une cuisson pauvre ou sans matière grasse.  
Rapport qualité / prix exceptionnel.  
Compatible induction.



**Hochwertige Greblon® Antihafbeschichtung**  
Greblon® non-stick coating  
Revêtement anti adhérent Greblon®



**Deckelknopf aus Edelstahl**  
Stainless steel knob  
Bouton en inox

**Griffe aus einem Guss**  
One-piece handles  
Poignées moulées



0-180°

0-230°

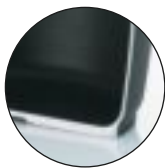

**Material Querschnitt**  
Cross-section  
Coupe transversale

**Allherdboden**  
Universal base  
Fond tous feux

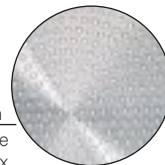



# Kerros



4,2 cm

**Bratpfanne 18 cm Ø**  
Frying pan · Poêle

1	-	6	🔥
<b>11560</b>		4025457115608	

4,2 cm

**Bratpfanne 20 cm Ø**  
Frying pan · Poêle

1	-	6	🔥
<b>11561</b>		4025457115615	

4,7 cm

**Bratpfanne 24 cm Ø**  
Frying pan · Poêle

1	-	6	🔥
<b>15150</b>		4025457151507	

5 cm

**Bratpfanne 28 cm Ø**  
Frying pan · Poêle

1	-	6	🔥
<b>15151</b>		4025457151514	

6 cm

**Bratpfanne 32 cm Ø**  
Frying pan · Poêle

1	-	6	🔥
<b>15154</b>		4025457151545	

7 cm

**Schmorpfanne 24 cm Ø 1,9 L**  
Stewing pan · Sauteuse

1	-	6	🔥
<b>11567</b>		4025457115677	

7 cm

**Schmorpfanne 28 cm Ø 2,3 L**  
Stewing pan · Sauteuse

1	-	6	🔥
<b>11568</b>		4025457115684	

1,5 cm

**Crêpe-Pfanne 28 cm Ø**  
Crêpe pan · Crêpière

1	-	6	🔥
<b>15155</b>		4025457151552	



4,5 cm

**Fischpfanne 34 x 23 cm**  
Fish pan · Poêle à poisson

1	-	6	🔥
<b>11559</b>		4025457115592	
2 Ausgüsse · 2 Spouts · 2 Becs verseur			

4 cm

**Grill-Eckpfanne 28 x 28 cm**  
Square griddle pan · Poêle à griller

1	-	6	🔥
<b>15156</b>		4025457151569	
2 Ausgüsse · 2 Spouts · 2 Becs verseur			

0-230°

**Grillplatte 30 x 24 cm**  
Flat griddle pan · Planche à griller

1	-	6	🔥
<b>11564</b>		4025457115646	

# Kerros



**Fleischtopf 16 cm Ø 1,0 L**  
Covered saucepot · Faitout

1 - 6 **11549** 4025457115493



**Fleischtopf 20 cm Ø 1,7 L**  
Covered saucepot · Faitout

1 - 6 **11550** 4025457115509



**Fleischtopf 24 cm Ø 3,2 L**  
Covered saucepot · Faitout

1 - 6 **11552** 4025457115523



**Servierpfanne 32 cm Ø 5,0 L**  
Serving pan · Sauteuse

1 - 4 **11554** 4025457115547



**Servierpfanne 36 cm Ø 7,0 L**  
Serving pan · Sauteuse

1 - 4 **11555** 4025457115554



**Wok 32 cm Ø 4,0 L**  
Wok · Wok

1 - 6 **15157** 4025457151576



**Aromaknopf -**  
zum Verfeinern des Bratgutes  
Lid with aroma knob  
Couvercle avec bouton arôme



**Feuerfester Deckel -**  
auch als Auflaufform verwendbar  
Fire-proof lid -  
Can also used as a baking dish  
Couvercle résistant au feu -  
Utilisable comme plat à four

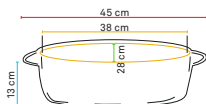

**Bräter 8,0 L**  
Roasting tray · Cocotte à braiser

1 - 4 **15153** 4025457151538

Aromaknopf · Aroma knob · Bouton arôme

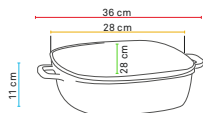

**Servierpfanne 28 x 28 cm 6,0 L**  
Serving pan · Sauteuse

1 - 4 **11553** 4025457115530

Aromaknopf · Aroma knob · Bouton arôme

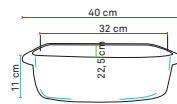

**Rechteck-Bräter 4,5 L**  
Rectangular roasting tray  
Cocotte à braiser rectangulaire

1 - 2 **15152** 4025457151521

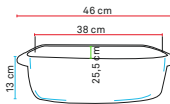

**Rechteck-Bräter 6,5 L**  
Rectangular roasting tray  
Cocotte à braiser rectangulaire

1 - 2 **11563** 4025457115639



# Stoneline®

**Schonendes und fettarmes Braten.**

Das Original, mit echten Steinpartikeln.  
Braten wie auf Naturstein.  
3-schichtige Antihftbeschichtung.

**For healthy and low-fat frying.**

The original material, with real particles of stone.  
Like frying on natural stone.  
3-layer non-stick coating.

**Une Cuisson saine et pauvre en matière grasse.**

L'Original, avec particules de pierre.  
Cuire comme sur de la pierre naturelle.  
Revêtement anti adhésif 3 couches.

Aluminium  
Aluminium forged  
Aluminium forgé



**STONELINE**

**Antihftbeschichtung**  
Non-stick coating  
Revêtement anti-adhésif

0-180°



**Allherdboden**

Universal base  
Fond tous feux



**Bratpfanne 16 cm Ø**  
Frying pan · Poêle

1 - 12 **16370** 4025457163708



**Bratpfanne 20 cm Ø**  
Frying pan · Poêle

1 - 6 **15474** 4025457154744



**Bratpfanne 24 cm Ø**  
Frying pan · Poêle

1 - 6 **15475** 4025457154751



**Bratpfanne 28 cm Ø**  
Frying pan · Poêle

1 - 6 **15476** 4025457154768



# Calido

Gusseisen  
Cast iron  
Fonte

**Die Ausdauernde,  
mit glatter Emaille**  
Sehr gut für langes Schmoren  
geeignet.  
Leicht zu reinigen.  
Induktionsgeeignet.

**The endurance pot,  
with a smooth enamel finish**  
Ideal for slow braising  
Easy to clean.  
Suitable for induction hobs.

**L'endurante,  
Emaille lisse.**  
Idéale pour mijoter.  
Facile d'entretien.  
Compatible induction.

**Innen: helle, glatte  
Emaille-Beschichtung**  
Bright, smooth  
enamel coating on the inside  
Revêtement extérieur émaillé

**Handliche Griffe**  
Practical handles  
Poignée ergonomiques

**Größenangabe  
im Deckel**  
Dimensions  
inside the lid  
Dimensions  
du couvercle

**Deckelknopf aus  
massivem Edelstahl**  
Stainless steel knob  
Bouton en acier inoxydable

0-300°

**Allherdboden**  
Universal base  
Fond tous feux



**Außen: glatte  
Emaille-Beschichtung  
Rotverlauf**  
Smooth enamel  
coating on the outside  
Enamel coating  
Revêtement émaillé







# Calido



**Bräter rund 21 cm Ø, 2,5 L**  
Roasting tray round · Cocotte ronde

1 - 2   
11940 4025457119408  
Rot/Beige · Red/Beige · Rouge/Beige

**Bräter rund 24 cm Ø, 4,0 L**  
Roasting tray round · Cocotte ronde

1 - 2   
11941 4025457119415  
Rot/Beige · Red/Beige · Rouge/Beige

**Bräter rund 26 cm Ø, 5,0 L**  
Roasting tray round · Cocotte ronde

1 - 2   
11948 4025457119484  
Rot/Beige · Red/Beige · Rouge/Beige

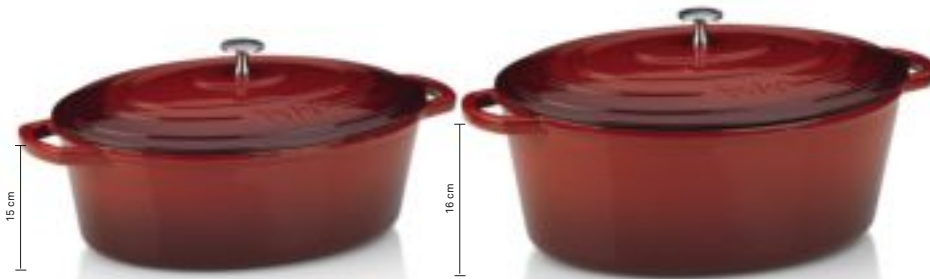

**Bräter oval 33 cm, 6,5 L**  
Roasting tray oval · Cocotte ovale

- - 1   
11942 4025457119422  
Rot/Beige · Red/Beige · Rouge/Beige

**Bräter oval 36 cm, 9,5 L**  
Roasting tray oval · Cocotte ovale

- - 1   
11943 4025457119439  
Rot/Beige · Red/Beige · Rouge/Beige



**Wok 36 cm Ø, 4 L**  
Wok · Wok

1 - 2   
11947 4025457119477  
Rot/Schwarz · Red/Black · Rouge/Noir  
Glasdeckel · Glass lid · Couvercle en verre



**Bauernpfanne 28 cm Ø, 2,8 L**  
Country frying pan · Mijoteuse

1 - 2   
11949 4025457119491  
Rot/Beige · Red/Beige · Rouge/Beige  
Glasdeckel · Glass lid · Couvercle en verre



# Minero

Gusseisen  
Cast iron  
Fonte

**Die Raffinierte, mit schwarz matter Emaille-Beschichtung.**  
Eignet sich hervorragend zum krossen Anbraten bei hohen Temperaturen.  
Die speziellen Oberfläche fördert die Entfaltung der Brataromen und verleiht den Speisen einen intensiven Geschmack.  
Induktionsgeeignet.

**The refined pot, with black matt enamel coating.**  
Ideal for searing at high temperatures. The special surface encourages the development of roasting flavours and lends dishes an intense flavour.  
Suitable for induction hobs.

**La raffinée avec revêtement émaillé mat**  
Idéale pour une cuisson croustillante à haute température.  
Le couvercle plat évite la déperdition de chaleur et décuple les arômes.  
Compatible induction.

**Schwarz-matte Emaille-Beschichtung innen und außen**

Matt black enamel coating on the inside and outside.  
Revêtement intérieur et extérieur émaillé noir mat.

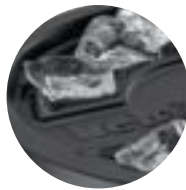

**Deckel vertieft für Eiswasser**

Lid indented for iced water  
Couvercle plat creux pour glaçons

**Deckelknopf aus massivem Edelstahl**

Stainless steel knob  
Bouton en Acier Inoxydable



**Handliche Griffe**  
Practical handles  
Poignée ergonomique



**Allherdboden**  
Universal base  
Socle tous feux



**KELA AROMA STARS**



**KELA AROMA STARS**

Für aromatische Kochergebnisse sorgen die Kela Aroma Stars an der Innenseite des Deckels. Sie verteilen die kondensierte Flüssigkeit gleichmäßig im Innenraum des Topfes und auf dem Bratgut.

**KELA AROMA STARS**

The Kela 'sky' of stars on the inside of the lid acts as a self-basting system and ensures the even distribution of the condensation in the interior. This improves the taste and preserves the nutritional values.

**KELA AROMA STARS**

Système d'arrosage continu sous forme d'étoiles sur la surface intérieure du couvercle formant des gouttelettes d'eau. Ces gouttelettes se dispersent de manière homogène sur les aliments pendant la cuisson dans le contenant.





# Ferrum

Eisen  
Iron  
Fer

**Die Klassische, mit silbergrauer, naturbelassener Oberfläche**  
Verändert die Farbe beim notwendigen Einbrennen und Benutzen der Pfanne.  
Genietet, ergonomischer Edelstahlgriff.  
Induktionsgeeignet.

**The classic pan, with a silver grey, natural surface**

Changes colour with the necessary burning in and use of the frying pan.  
Riveted, ergonomic stainless steel handle. Suitable for induction hobs.

**La Classique, avec fond naturel gris**

le fond noirci naturellement au fil des cuissons successives.  
Poignée ergonomique rivetée.  
Compatible induction.



**Genietet ergonomischer Griff**

Riveted ergonomic handle  
Poignée ergonomique rivetée

Edelstahl  
Stainless steel · inox



0-300°

**2 mm Wandstärke**

Wall thickness  
Épaisseur de paroi

**Allherdboden**

Universal base  
Fond tous feux



**Bratpfanne 24 cm Ø**  
Frying pan · Poêle

1 - 6

11616 4025457116162



**Bratpfanne 28 cm Ø**  
Frying pan · Poêle

1 - 6

11617 4025457116179





# Fergus

Die Maskuline, mit schwarz vorbehandelter Oberfläche Farbe und Oberfläche bleiben weitestgehend erhalten. Genietet, ergonomischer Edelstahlgriff. Induktionsgeeignet.

**The masculine pan, with a black, pre-treated surface**  
The colour and finish remains largely retained. Riveted, ergonomic stainless steel handle. Suitable for induction hobs.

**La Masculine avec son fond noir prétraité**  
la surface et la couleur ne se détériore pas. Poignée en acier inoxydable ergonomique rivetée. Compatible induction.



**Genietet ergonomischer Griff**

Riveted ergonomic handle  
Poignée ergonomique rivetée.

Edelstahl  
Stainless steel · Inox

0-300°

2 mm **Wandstärke**  
Wall thickness  
épaisseur de paroi

**Allherdboden**

Universal base  
Fond tous feux



**Bratpfanne 28 cm Ø**  
Frying pan · Poêle

1 - 6   
12305 4025457123054



**Bratpfanne 30 cm Ø**  
Frying pan · Poêle

1 - 6   
12306 4025457123061





# Stratum

Kupfer  
Copper  
Cuivre

**Die Professionelle in edlem Design.**  
Die außergewöhnlich schnelle Wärmeleitung ins Innere beschleunigt den Garvorgang.  
Energiesparend durch lange Wärmespeicherung im Inneren.  
Beliebt in der Profiküche.  
Induktionsgeeignet.

**The professional pot, with a sophisticated design.**  
The exceptionally fast heat conduction into the interior speeds up the cooking process.  
Energy-saving thanks to lasting heat retention in the interior.  
Popular in professional kitchens.  
Suitable for induction hobs.

**La Professionnelle design Noble**  
La diffusion intérieure rapide de la chaleur accélère la cuisson.  
Très peu de déperdition de chaleur et économie d'énergie.  
L'une des préférées des professionnels. Compatible induction.

### Deckel aus Edelstahl 18/10

Stainless steel 18/10  
Couvercle inox 18/10

Edelstahl 18/10  
Stainless steel - Inox

### Schüttrand

Pouring rim  
Avec rebord verseur



### Genietet, ergonomische Griffe

Riveted, ergonomic handles  
Poignée rivetée en fonte d'acier inoxydable

Edelstahl 18/10  
Stainless steel - Inox

0-300°

2,2 mm **Wandstärke**  
Wall thickness  
Épaisseur de paroi

### Allherdboden

Universal base  
Fond tous feux

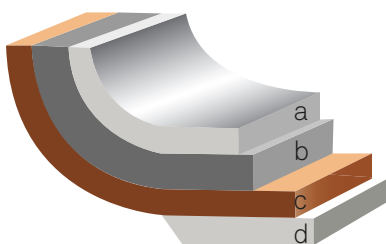
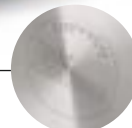

- a: 0,5 mm - 18/10 Edelstahl · Stainless steel · Inox
- b: 1,2 mm - Aluminium
- c: 0,5 mm - Kupfer · Copper · Cuivre
- d: Induktionsboden · Universal base · Fond tous feux

# Stratum



**Stielkasserolle 16 cm Ø, 1,4 L**  
Casserole with handle  
Casserole à manche

1 - 4

**11145** 4025457111457

**Stielkasserolle 20 cm Ø, 2,8 L**  
Casserole with handle  
Casserole à manche

1 - 4

**11146** 4025457111464

**Bratentopf 24 cm Ø, 4,8 L**  
Saucepot  
Faitout

1 - 2

**11147** 4025457111471



**Bratpfanne Stratum 20 cm Ø**  
Frying pan · Poêle

1 - 6

**11132** 4025457111327

**Bratpfanne 24 cm Ø**  
Frying pan · Poêle

1 - 6

**11130** 4025457111303

**Bratpfanne 28 cm Ø**  
Frying pan · Poêle

1 - 6

**11131** 4025457111310





# Cailin

Edelstahl 18/10  
Stainless steel 18/10  
Inox 18/10

**Die Traditionelle in Glanzoptik.**  
Bewährtes Design.  
Der Glasdeckel schafft Durchblick.  
Einstiegspreislage.  
Induktionsgeeignet.

**The traditional pot, with a glossy finish.**  
Proven design. The glass lid lets you keep an eye on your cooking food.  
Entry-level price.  
Suitable for induction hobs.

**La Traditionelle Tout en brillance**  
Design contemporain.  
Couvercle en verre transparent.  
Excellent rapport qualité/prix.  
Compatible induction.



**Deckelknopf aus Edelstahl**

Stainless steel knob  
Bouton en inox

**Schüttrand**

Pouring rim  
Avec rebord verseur

0-180°

**Glasdeckel**

Glass lid  
Couvercle en verre

0-300°

**Allherdboden**

Universal base  
Fond tous feux





# Cailin



**Milchtopf 14 cm Ø, 1,8 L**  
Milk pot · Pot à lait

1 - 12

**10963** 4025457109638



**Stielkasserolle 16 cm Ø, 1,5 L**  
Casserole with handle  
Casserole à manche

1 - 6

**10964** 4025457109645

**10963 und 10964 mit Innenskalerung**  
10963 and 10964 with interior scaling  
10963 et 10964 avec échelle de mesure intérieure



**Bratentopf 16 cm Ø, 1,5 L**  
Saucepot · Faitout

1 - 6

**10955** 4025457109553



**Bratentopf 20 cm Ø, 3,0 L**  
Saucepot · Faitout

1 - 4

**10956** 4025457109560



**Bratentopf 24 cm Ø, 5,0 L**  
Saucepot · Faitout

1 - 4

**10957** 4025457109577



**Gemüsetopf 24 cm Ø, 9,0 L**  
Stock pot · Marmite

1 - 2

**10961** 4025457109614



**Fleischtopf 16 cm Ø, 1,7 L**  
Covered saucepot · Faitout

1 - 6

**10958** 4025457109584



**Fleischtopf 20 cm Ø, 3,5 L**  
Covered saucepot · Faitout

1 - 4

**10959** 4025457109591



**Fleischtopf 24 cm Ø, 6,0 L**  
Covered saucepot · Faitout

1 - 4

**10960** 4025457109607



**Gemüsetopf 28 cm Ø, 13,5 L**  
Stock pot · Marmite

1 - 2

**10962** 4025457109621

# Cailin



Der Dünster eignet sich bestens zum Dämpfen von Kartoffeln oder auch Gemüse.

The steamer is ideal for stewing potatoes or vegetables.

Le cuseur vapeur est particulièrement adapté pour la cuisson de légumes et pommes de terre.



Pastatopf, mit Pasta-Siebeinsatz, zur einfachen Handhabung.

With pasta strainer insert – for easy handling.

Avec passoire pasta – pour une utilisation simple.



**Fondue-Set**  
Fondue-set · Service à fondue

1 - 4

**10968** 4025457109683

10-teilig · 10 pieces · 10 pièces

a 18/10 Edelstahl · Stainless steel · Inox  
b Edelstahl · Stainless steel · Inox



**Universal-Dünster 20 cm Ø, 2,4 L**  
Bio-steamer · Cuit Vapeur

1 - 4

**10994** 4025457109942

Mit Einsatz · With insert · Avec panier



**Pastatopf Cailin 24 cm Ø, 5,8 L**  
Pasta pot · Cuit pâtes

1 - 4

**10991** 4025457109911

Mit Einsatz · With insert · Avec panier



**Bratpfanne 20 cm Ø**  
Frying pan · Poêle

1 - 6

**11673** 4025457116735



**Bratpfanne 24 cm Ø**  
Frying pan · Poêle

1 - 6

**11674** 4025457116742



**Bratpfanne 28 cm Ø**  
Frying pan · Poêle

1 - 6

**11675** 4025457116759



**Bratpfanne 20 cm Ø**  
Frying pan · Poêle

1 - 6

**11670** 4025457116704



**Bratpfanne 24 cm Ø**  
Frying pan · Poêle

1 - 6

**10965** 4025457109652



**Bratpfanne 28 cm Ø**  
Frying pan · Poêle

1 - 6

**10966** 4025457109669



**Greblon® Antihafbeschichtung**  
Greblon® non-stick coating  
Revêtement anti adhérent Greblon®

# Cailin



16 cm Ø, 24 cm Ø : Fleischtopf · Covered saucepot · Faitout  
 20 cm Ø : Bratentopf · Saucepot · Faitout  
 16 cm Ø : Stielkasserolle · Casserole with ong handle · Casserole à manche

**Kochtopf-Set Cailin 4-tlg.**  
 Cooking pot set · Set casseroles

1 - 2

10969 4025457109690



# SET

## Dampfentsafter Frutta

Edelstahl 18/10 in Glanzoptik · Glasdeckel  
 Stainless steel 18/10 · Bright · Lid glass  
 Inox 18/10 · Brillant · Couvercle Verre



**Dampfentsafter 25 cm Ø**  
 Steam juicer  
 Extracteur de jus à vapeur

1 - 4

10992 4025457109928

**Fruchtkorb**  
 Collection vessel  
 Récipient récupérateur

**Pasteurisierte Saft**  
 Pasteurised juice  
 Jus pasteurisé

**Kochendes Wasser**  
 Boiling water  
 Eau bouillante

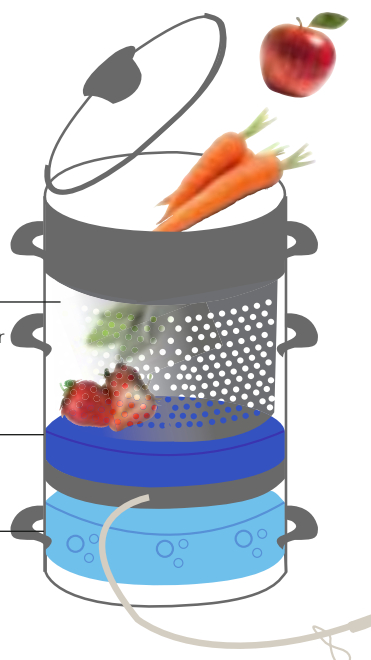

Geschmacks- und geruchsneutral, lebensmittelecht, säurefest und spülmaschinengeeignet (Ausnahme: Silikon Schlauch). Der Kapselboden sorgt für eine gleichmäßige Wärmeverteilung und -speicherung.

No taste or odour, is food-safe, acid-resistant and dishwasher-safe (exception: silicone hose). The capsule floor ensures an even heat distribution and storage.

Est parfaitement neutre quant aux goûts et aux odeurs, constitué d'un matériau adapté au contact alimentaire, résistant aux acides alimentaires et adapté au lave-vaisselle (à l'exception du tuyau en silicone).

Le fond en capsule garantit une répartition et un stockage homogène de la chaleur.



# Niklas

Edelstahl 18/10  
Stainless steel 18/10  
Inox 18/10

**Die Moderne, mit Glanz-Akzenten.**  
Gerade Form.  
Stabile Griffe.  
Optik matt/glänzend.  
Trendiger, flacher Glasdeckel.  
Induktionsgeeignet.

**The modern pot, making a glossy statement.**  
Straight shape.  
Sturdy handles.  
Matt/gloss look.  
Fashionable, flat glass lid.  
Suitable for induction hobs.

**La Moderne, Avec ses accents brillants.**  
Forme droite.  
Poignée Stable.  
Effet mat / brillant.  
Couvercle plat en verre tendance.  
Compatible induction.

**Glasdeckel flach, mit breitem Edelstahlrand**

Glass lid with a flat stainless steel rim  
Couvercle plat avec rebord acier inoxydable

**Schüttrand**

Pouring rim  
Avec rebord verseur



**Sehr stabile Griffe**

Very stable handles  
Poignées stables

0-180°

0-300°

**Wandstärke**

Wall thickness  
épaisseur de paroi

0,6 mm



**Allherdboden**

Universal base  
Fond tous feux





# Niklas



**Bratentopf 16 cm Ø, 1,2 L**

Saucepot · Faitout

1 - 6

**12200** 4025457122002



**Bratentopf 20 cm Ø, 2,4 L**

Saucepot · Faitout

1 - 4

**12201** 4025457122019



**Bratentopf 24 cm Ø, 4,1 L**

Saucepot · Faitout

1 - 4

**12202** 4025457122026

Der Dünsteinsatz eignet sich bestens zum Dämpfen von Kartoffeln oder Gemüse.

The steamer is ideal for stewing potatoes or vegetables.

Le cuit vapeur est particulièrement adapté pour la cuisson de légumes et pommes de terre.



**Fleischtopf 16 cm Ø, 1,5 L**

Covered saucepot · Faitout

1 - 6

**12203** 4025457122033



**Fleischtopf 20 cm Ø, 3,0 L**

Covered saucepot · Faitout

1 - 4

**12204** 4025457122040



**Fleischtopf 24 cm Ø, 4,8 L**

Covered saucepot · Faitout

1 - 4

**12205** 4025457122057



**Universal-Dünster 20 cm Ø, 2,4 L**

Bio-steamer · Cuisseur vapeur

1 - 4

**12208** 4025457122088

Mit Einsatz · With insert · Avec panier



**Milchtopf 14 cm Ø, 1,5 L**

Milk pot · Pot à lait

1 - 12

**12207** 4025457122071



**Stielkasserolle 16 cm Ø, 1,2 L**

Casserole with handle · Casserole à manche

1 - 6

**12206** 4025457122064



**12207 und 12206**

Mit Innenskalierung.

With interior scaling.

Avec échelle de mesure intérieure

**Kochtopf-Set Niklas 4-tlg.**

Cooking pot set · Set casseroles

1 - 2

**10953** 4025457109539

16 cm Ø, 24 cm Ø : Fleischtopf · Covered saucepot · Faitout

20 cm Ø : Bratentopf · Saucepot · Faitout

16 cm Ø : Stielkasserolle · Casserole with ong handle · Casserole à manche



# SET



# Ivo

Edelstahl 18/10  
Stainless steel 18/10  
Inox 18/10

**Funktionsbräter.**  
Hochwertiges Edelstahl.  
Handliche, große Griffe.  
Energiesparboden durch  
IMPACT BONDING.  
Induktionsgeeignet.  
Spülmaschinengeeignet.

**Functional roasting pans.**  
High-grade stainless steel.  
Practical large handles.  
Energy-saving base, thanks to  
IMPACT BONDING.  
Suitable for induction hobs.  
Dishwasher-safe.

**Les Multi-fonctions**  
Acier Inoxydable Haut de gamme.  
Grandes poignées fonctionnelles.  
Fond à économie d'énergie système  
Impact Bonding.  
Compatible Induction.  
Compatible Lave Vaisselle



**Multi-Bräter 39 x 28 cm 5,7 L**  
Multi-roaster · Cuit Vapeur rectangulaire  
1 - 3   
**12402** 4025457124020

**2 in 1: Deckel als Servierpfanne  
verwendbar / induktionsfähig**  
2 in 1: the lid can also be used as a  
serving pan – suitable for use on  
induction hobs  
2 in 1: Couvercle utilisable comme  
plat de service Compatible induction



**Bräter oval 40 x 27,5 cm 7,3 L**  
Roasting tray oval · Daubière Ovale  
1 - 3   
**12401** 4025457124013

**Bräter oval 40 x 27,5 cm 7,3 L**  
Roasting tray oval · Daubière Ovale  
1 - 3   
**12401** 4025457124013



**Dampfgarer 44 x 27 cm 5,8 L**  
Steam cookers · Cuit Vapeur  
1 - 3   
**12400** 4025457124006  
Mit Einsatz · With insert · Avec insert  
Deckel: Glas · Lid: glass · Couvercle: verre

**Dampfgarer 44 x 27 cm 5,8 L**  
Steam cookers · Cuit Vapeur  
1 - 3   
**12400** 4025457124006  
Mit Einsatz · With insert · Avec insert  
Deckel: Glas · Lid: glass · Couvercle: verre



# Woks

Auch für Induktion geeignet  
Suitable even for induction cookers  
Compatible induction



Wok-Set Mini 24 cm Ø, 1,6 L

Wok set · Set Wok

1 - 3

77747 4025457777479

5-teilig · 5 pieces · 5 pièces

- a Gusseisen · Cast iron · Fonte de fer
- b Glas · Glass · Verre
- c Edelstahl · Stainless steel · Inox
- d Bambus · Bamboo · Bambou



Wok-Set Asia 36 cm Ø, 4,5 L

Wok set · Set Wok

1 - 2

77943 4025457779435

5-teilig · 5 pieces · 5 pièces

- a Gusseisen · Cast iron · Fonte de fer
- b Metall · Metal · Métal
- c Edelstahl · Stainless steel · Inox
- d Bambus · Bamboo · Bambou

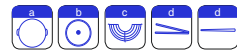

Wok Kerros 32 cm Ø, 4,0 L

Wok · Wok

1 - 6

15157 4025457151576

Aluguss  
Cast aluminium · Fonte d'aluminium



Wok Calido 36 cm Ø, 4 L

Wok · Wok

1 - 2

11947 4025457119477

Glasdeckel · Glass lid · Couvercle en verre

Gusseisen emailiert  
Cast iron enamelled · Fonte émaillée

Rot/Schwarz · Red/Black · Rouge/Noir

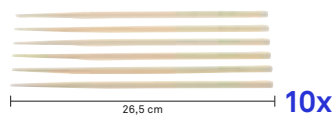

Chopsticks Asia

Chopsticks · Chopsticks

1 - 100

77905 4025457779053

10 Paar · 10 Pairs · 10 Paires



Dämpf-Set Vital

Steamer set · Cuit vapeur

1 - 18

77160 4025457771606

3-teilig · 3 pieces · 3 pièces

2x Dämpfkörbchen · 1x Deckel  
2x Steamer baskets · 1x Lid  
2x Corbeilles · 1x Couvercle

# Zubehör

Bambus  
Bamboo  
Bambou



# Concetta & Callisto

## Concetta

Glas · Silikonrand · schwarz  
 Glass · Silicone rim  
 Verre · Rebord Silicone



Universaldeckel passt sich Töpfen und Pfannen über drei Größen an. Mit Silikonrand, und Dampfauslass-ventil.

The all-purpose lid fits three sizes of pots and pans. With silicone rim, and steam vent.

Le couvercle universel s'adapte à toutes les poêles et casseroles sur 3 dimensions. Avec rebord en silicone, et évacuateur de vapeur.



<b>Glasdeckel</b>	
Glass lid · Couvercle en verre	
1	6 12
<b>11440</b>	4025457114403
Schwarz · Black · Noir	
Passend für: · Suitable for: · Convient pour: 16/18/20 cm Ø	



<b>Glasdeckel</b>	
Glass lid · Couvercle en verre	
1	6 12
<b>11441</b>	4025457114410
Schwarz · Black · Noir	
Passend für: · Suitable for: · Convient pour: 22/24/26 cm Ø	



<b>Glasdeckel</b>	
Glass lid · Couvercle en verre	
1	6 12
<b>11442</b>	4025457114427
Schwarz · Black · Noir	
Passend für: · Suitable for: · Convient pour: 28/30/32 cm Ø	

## Callisto

Glas · Edelstahlrand  
 Bakelitknopf schwarz  
 Glass · Stainless steel rim  
 Bakelite knob black  
 Verre · Rebord en acier  
 Bouton bakélite noir



<b>Glasdeckel 16 cm Ø</b>	
Glass lid · Couvercle en verre	
1	- 16
<b>10870</b>	4025457108709



<b>Glasdeckel 20 cm Ø</b>	
Glass lid · Couvercle en verre	
1	- 16
<b>10871</b>	4025457108716



<b>Glasdeckel 24 cm Ø</b>	
Glass lid · Couvercle en verre	
1	- 8
<b>10872</b>	4025457108723



<b>Glasdeckel 28 cm Ø</b>	
Glass lid · Couvercle en verre	
1	- 8
<b>10873</b>	4025457108730



<b>Pfannen-Glasdeckel 24 cm Ø</b>	
Glass lid · Couvercle en verre	
1	- 8
<b>10995</b>	4025457109959



<b>Pfannen-Glasdeckel 28 cm Ø</b>	
Glass lid · Couvercle en verre	
1	- 10
<b>10996</b>	4025457109966



# Pfannenschoner Amparo

Schoner aus Filz für Kochgeschirr

Protect your cookware and table perfectly · Felt

Protection parfaite pour les ustensiles de cuisson et la table · Feutre



31/35/39 cm Ø **3x**

### Pfannenschutz-Set

Pan protection set · Set protection poêle

- 12\* 24

**11650** 4025457116506

3-teilig · 3 pieces · 3 pièces

Filz · Felt · Feutre 3 mm

2x Grün · 1x Grau  
2x Green · 1x Grey  
2x Vert · 1x Gris

31/35/39 cm Ø **3x**

### Pfannenschutz-Set

Pan protection set · Set protection poêle

- 12\* 24

**11652** 4025457116520

3-teilig · 3 pieces · 3 pièces

Filz · Felt · Feutre 3 mm

2x Schwarz · 1x Grau  
2x Black · 1x Grey  
2x Noir · 1x Gris



### Spritzschutz Elvira

Splash guard · Grille anti-éclaboussures

1 - 24

**11476** 4025457114762

18/10 Edeltahl · Stainless steel · Inox

Passend für: Suitable for: · Convient pour: 20/24/28 cm Ø

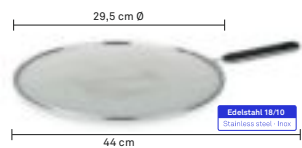

### Spritzschutz Cosima

Splash guard · Grille anti-éclaboussures

1 24 72

**17116** 4025457171161

18/10 Edeltahl · Stainless steel · Inox

## Spritzschutz

Für ein sauberes Braten

Splash guard

Pour une Cuisson propre

# Maila

Keramik matt · Gummibaum

Ceramik matt · Rubber tree

Céramique mat · Yucca



**Salz-/ Pfefferstreuer 2-er Set**  
Salt / pepper shaker  
Salière et poivrière

1 - 48

**12484** 4025457124846

2-teilig · 2 pieces · 2 pièces



**Schälchen**  
Bowl · Coupelle

1 4 36

**12485** 4025457124853



**Schüssel**  
Bowl · Coupelle

1 2 18

**12486** 4025457124860



**Schüssel**  
Bowl · Coupelle

1 - 8

**12487** 4025457124877



**Servier- und Auflaufform**  
Casserole dish · Plat à four

1	2	8	
12482	4025457124822		

**Servier- und Auflaufform**  
Casserole dish · Plat à four

1	2	8	
12483	4025457124839		

**Vorratsdose**  
Storage jar · Bocal hermétique

-	4*	12	0,8 L
12480	4025457124808		

**Vorratsdose**  
Storage jar · Bocal hermétique

-	4*	12	1,3 L
12481	4025457124815		

# Servier- und Auflaufform Ester

Porzellan weiß · Glänzend  
 Porcelain white · Bright  
 Porcelaine blanche · Brillant

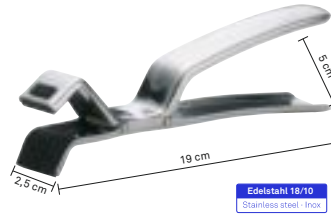

**Ofenzange Maria**  
 Oven tongs · Pince à four

1 6 60

**10826** 4025457108266

18/10 Edelstahl · Stainless steel · Inox

Silikon · Silicone · Silicône



Mit dieser Zange kann eine Back- oder Ofenform sicher gegriffen und aus dem heißen Ofen genommen oder hineingeschoben werden.

Use these tongs to hold a baking tray or oven dish safely and remove or insert it into a hot oven.

Cette pince permet une manipulation simple d'un plat à four, pour mettre ou retirer du four chaud.



**Servier- und Auflaufform**  
 Casserole dish · Plat à four

1 3 12

**11685** 4025457116858



**Servier- und Auflaufform**  
 Casserole dish · Plat à four

1 2 8

**11686** 4025457116865



**Servier- und Auflaufform**  
 Casserole dish · Plat à four

1 2 8

**11687** 4025457116872



**Servier- und Auflaufform**  
 Casserole dish · Plat à four

1 2 6

**11688** 4025457116889

## Schälchen Maleen

Porzellan weiß  
 Porcelain white  
 Porcelaine blanche



**Schälchen Maleen**  
 Crème brûlée dish  
 Ramequin crème brûlée

6\* 48

**10763** 4025457107634

Glänzend · Bright · Brillant

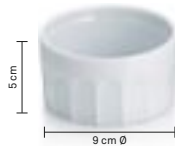

**Schälchen Maleen**  
 Crème brûlée dish  
 Coupelles crème brûlée

- 6\* 48

**10759** 4025457107597

Glänzend · Bright · Brillant



**Gourmet-Gasbrenner Manou**  
 Gourmet gas burner · Gourmet brûleur gaz

1 - 20

**10947** 4025457109478

Metall · Metal · Métal

Silber · Silver · Argent



**Crème Brûlée-Set Manou**  
 Crème brûlée set · Set de crème brûlée

1 - 8

**10948** 4025457109485

5-teilig · 5 pièces · 5 pièces

4x Schälchen, 1x Gasbrenner  
 4x Dishes, 1x Gas burner  
 4x Coupelles, 1x Gourmet brûleur gaz



# Servier- und Auflaufform Malin

Keramik rot/beige · Glänzend  
 Ceramic red/beige · Bright  
 Céramique rouge/beige · Brillant



Servier- und Auflaufform  
 Casserole dish · Plat à four

- 4\* 12

---

11860 4025457118609

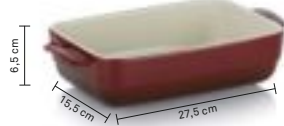

Servier- und Auflaufform  
 Casserole dish · Plat à four

- 4\* 8

---

11861 4025457118616



Servier- und Auflaufform  
 Casserole dish · Plat à four

- 3\* 6

---

11862 4025457118623



Servier- und Auflaufform  
 Casserole dish · Plat à four

- 3\* 6

---

11863 4025457118630



Servier- und Auflaufform  
 Casserole dish · Plat à four

- 3\* 12

---

11864 4025457118647



Servier- und Auflaufform  
 Casserole dish · Plat à four

- 3\* 24

---

11865 4025457118654







# Zuverlässige Helferlein

Reliable utensils

Accessoires d'aides à la cuisson



# Rondo

Edelstahl matt  
Stainless steel matt  
Inox mat



**Pfannenwender**  
Slotted spatula · Spatule ajourée

1 12 72

19003 4025457190032



**Schaumlöffel**  
Skimmer · Mousseur

1 12 72

19005 4025457190056



**Kartoffelstampfer**  
Potato masher · Ecrase pomme de terre

1 12 72

19006 4025457190063



**Servierlöffel**  
Serving spoon · Cuillère à service

1 12 72

19007 4025457190070



**Saucenlöffel**  
Gravy ladle · Cuillère à sauce

1 12 72

19002 4025457190025



**Suppenschöpfer**  
Soup ladle · Louche

1 12 72

19001 4025457190018



**Spaghettilöffel**  
Spaghetti spoon · Cuillère à spaghetti

1 12 72

19061 4025457190612

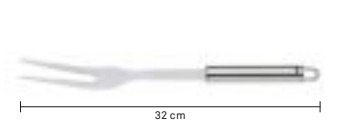

**Fleischgabel**  
Carving fork · Fourchette à viande

1 12 72

19004 4025457190049



**Kuchenpalette**  
Icing spatula · Spatule plate

1 12 72

19140 4025457191404



**Winkelpalette**  
Icing spatula · Spatule coudée

1 12 72

19139 4025457191398

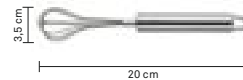

**Mini-Schneebeesen**  
Mini egg whisk · Fouet mini

1 24 144

19024 4025457190247



**Schneebeesen**  
Egg whisk · Fouet plat

1 10 150

19028 4025457190285



# Rondo



**Schneebeesen**  
Egg whisk · Fouet

1	12	144
<b>19019</b>	4025457190193	



**Schneebeesen**  
Egg whisk · Fouet

1	12	120
<b>19027</b>	4025457190278	

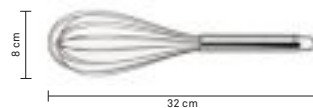

**Schneebeesen**  
Egg whisk · Fouet

1	12	96
<b>19020</b>	4025457190209	

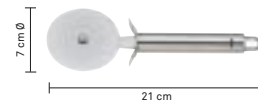

**Pizzaschneider**  
Pizza cutter · Roulette à pizza

1	12	72
<b>19013</b>	4025457190131	



**Kaffeesieb**  
Coffee strainer · Passoire à café

1	12	144
<b>19017</b>	4025457190179	



**Eisportionierer**  
Ice cream scoop · Cuillère à glace

1	12	96
<b>19022</b>	4025457190223	



**Eisportionierer**  
Ice cream scoop · Cuillère à glace

1	12	72
<b>19135</b>	4025457191350	



**Gewürzreibe**  
Spice grater · Râpe épices

1	12	144
<b>19010</b>	4025457190100	



**Dosenöffner**  
Can opener · Ouvre-boîte

1	12	48
<b>19000</b>	4025457190001	

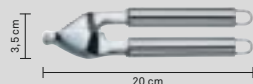

**Knoblauchpresse**  
Garlic press · Presse-ail

1	12	48
<b>19062</b>	4025457190629	



Perfekte Reinigung durch  
Silikonknoppen auf der Rückseite  
Perfect cleaning  
Nettoyage facile

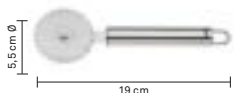

**Teigrad**  
Pastry wheel · Roulette à pâte

1	12	144
<b>19014</b>	4025457190148	



**Kuchenpinsel**  
Kitchen brush · Pinceau de cuisine

1	12	144
<b>15931</b>	4025457159312	
Silikon · Silicone · Silicone		
Schwarz · Black · Noir		



**Tortenheber**  
Cake server · Pelle à tarte

1	12	144
<b>19016</b>	4025457190162	



**Zestenreißer**  
Zester · Zesteur

1	12	144
<b>19033</b>	4025457190339	



**Apfelsausstecher**  
Apple corer · Vide pomme

1	12	144
<b>19012</b>	4025457190124	



**Sparschäler Y-Form**  
Potato peeler · Rasoir à légumes forme Y

1	12	144
<b>19038</b>	4025457190384	



**Sparschäler**  
Potato peeler · Eplucheur

1	12	216
<b>19009</b>	4025457190094	



**Sparschäler**  
Potato peeler · Rasoir pomme de terre

1	12	144
<b>19039</b>	4025457190391	



**Käsemesser**  
Cheese knife · Couteau à fromage

1	12	120
<b>15326</b>	4025457153266	



**Käseschneider**  
Cheese cutter · Eminceur fromage

1	12	144
<b>19029</b>	4025457190292	



**Palette**  
Palette spatula · Spatule plate

1	12	144
<b>19032</b>	4025457190322	

# Küchenhelfer



## Bollita

Edelstahl · Soft touch Griff mit TPR-Beschichtung  
Stainless steel · Soft-touch handle with TPR coating  
Inox noir – manche Soft Touch

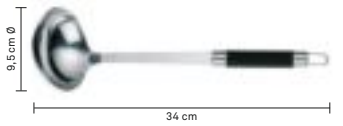

**Suppensöpfer**  
Soup ladle · Louche

1 24 48  
11230 4025457112300

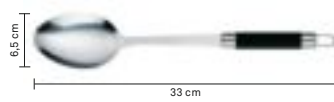

**Servierlöffel**  
Serving spoon · Cuillère à service

1 24 48  
11228 4025457112287



**Spaghettilöffel**  
Spaghetti spoon · Cuillère à spaghetti

1 24 48  
11229 4025457112294



**Schaumlöffel**  
Skimmer · Mousseur

1 24 48  
11226 4025457112263

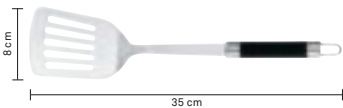

**Pfannenwender**  
Slotted spatula · Spatule ajourée

1 24 48  
11227 4025457112270



**Schneebesen**  
Egg whisk · Fouet

1 24 48  
11231 4025457112317



## Bill

Griff Edelstahl · Nylon grau  
Handle stainless steel · Nylon grey  
Poignée inox · Gris nylon



**Suppensöpfer**  
Soup ladle  
Louche à potage

1 6 48  
12163 4025457121630



**Servierlöffel geschlossen**  
Serving spoon closed  
Cuillère à servir

1 6 48  
12161 4025457121616



**Servierlöffel geschlitzt**  
Serving spoon slotted  
Cuillère à Service ajourée

1 6 48  
12162 4025457121623



**Pfannenwender**  
Slotted spatula  
Spatule ajourée

1 6 48  
12160 4025457121609

# Küchenhelfer

## Maribor

Buche  
Beech  
Hêtre

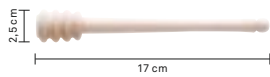

**Honiglöffel**  
Honey spoon · Cuillère à miel

1 10 480  
**23355** 4025457233555  
Ahorn · Maple · Erable

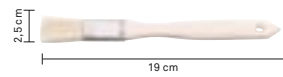

**Backpinsel**  
Baking brush · Pinceau de cuisine

1 20 400  
**23344** 4025457233449

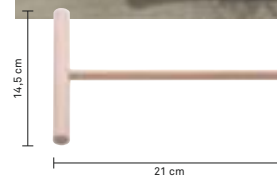

**Crêpe-Schieber**  
Crêpe-slide · Spatule crêpe

1 10 250  
**23354** 4025457233548



**Gurkenzange**  
Cucumber tongs · Pince à cornichons

1 10 240  
**23349** 4025457233494



**Spitzkochlöffel mit Loch**  
Pointed hole cooking spoon  
Cuillère pointue avec trou

1 10 500  
**23335** 4025457233357

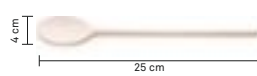

**Kochlöffel**  
Kitchen spoon · Cuillère

1 10 600  
**23331** 4025457233319

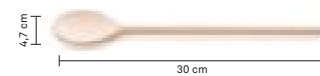

**Kochlöffel**  
Kitchen spoon · Cuillère

1 10 500  
**23332** 4025457233326

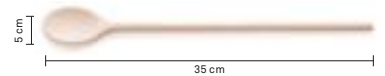

**Kochlöffel**  
Kitchen spoon · Cuillère

1 10 400  
**23333** 4025457233333

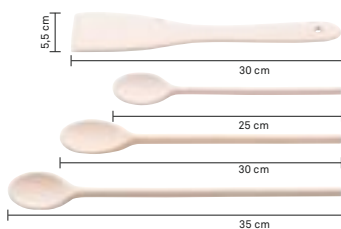

**Kochlöffel-Set**  
Kitchen spoon set · Set cuillères

1 - 50  
**17253** 4025457172533

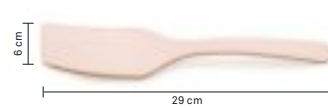

**Pfannenwender**  
Spatula · Spatule

1 10 400  
**23341** 4025457233418

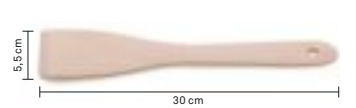

**Pfannenwender**  
Spatula · Spatule

1 10 450  
**23338** 4025457233388

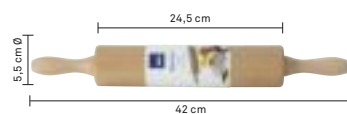

**Teigroller**  
Rolling pin · Rouleau à pâtisserie

1 - 12   
**23347** 4025457233470

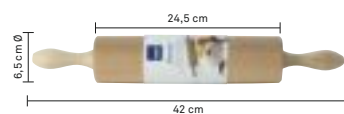

**Teigroller mit Kugellager**  
Rolling pin with ball bearing  
Rouleau à pâtisserie à roulement à billes

1 - 12   
**17300** 4025457173004

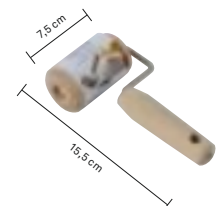

**Backblechroller**  
Pastry roller · Rouleau à pâte

1 - 12   
**17304** 4025457173042

# Küchenhelfer Livia

Buche  
Beech  
Hêtre



<b>Kochlöffel mit Loch</b> Kitchen spoon with hole · Cuillère à trou
1 24 96
<b>11784</b> 4025457117848

<b>Kochlöffel</b> Kitchen spoon · Cuillère
1 24 96
<b>11783</b> 4025457117831

<b>Pfannenwender geschlossen</b> Spatula · Spatule
1 24 96
<b>11781</b> 4025457117817

<b>Pfannenwender geschlitzt</b> Spatula · Spatule
1 24 96
<b>11782</b> 4025457117824



# Solido / Pino im Verkaufsddisplay

Zinkdruckguss verchromt  
Zinc die-cast chromed  
Zinc moulé sous pression chromé



**Pizzaschneider Solido**  
Pizza cutter · Roulette à pizza

- 12\* 48

**10031** 4025457054068

Display L 38 cm / T16 / H24,5



**Sparschäler Solido**  
Potato peeler · Eplucheur

- 12\* 48

**10032** 4025457054075

Display L 28 cm / T11,5 / H24,5



**Knoblauchpresse Solido**  
Garlic press · Presse-ail

- 12\* 24

**10036** 4025457054112

Display L 29,5 cm / T11,5 / H24

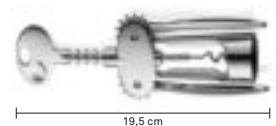

**Flügelkorkenzieher Solido**  
Wing corkscrew · Tire-bouchon à levier

- 12\* 24

**10037** 4025457054129

Display L 36 / T18 / H28



**Eislöffel Solido**  
Ice cream scoop · Cuillère à glace

- 12\* 48

**10035** 4025457054105

Display L 21,5 / T11,5 / H23,5 cm



**Dosenöffner Solido**  
Can opener · Ouvre-boîte

- 12\* 24

**10038** 4025457054136

Display L 31 / T18 / H26,5

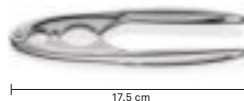

**Nussknacker Solido**  
Nutcracker · Casse noix

- 12\* 24

**10033** 4025457054082

Display L 32 / T14 / H24,5



**Nussknacker Pino**  
Nutcracker display · Display casse noix

- 12\* 48

**11468** 4025457047381

Gummierte Griffe · Rubberised handles · Poignées caoutchoutées

Schwarz · Black · Noir

Display L 19 / T11 / H17

# Hamburgerpresse Buffalo

Aluguss antihafbeschichtet

Cast aluminum non-stick coating

Revêtement antiadhésif en fonte d'aluminium



Die Hamburgerpresse wird mit einer kleinen Rezeptbroschüre & 50 Antihafpapieren geliefert.

With 3 delicious recipes.

50 x Non-stick paper.

Avec 3 délicieuses recettes.

50x Papier anti-adhésif.



**Hamburgerpresse Buffalo**  
Burger press · Presse à hamburger

1 12 24

**11715** 4025457117152

Aluguss antihafbeschichtet  
Cast aluminum non-stick coating  
Revêtement antiadhésif en fonte d'aluminium

Hamburger 11 cm Ø

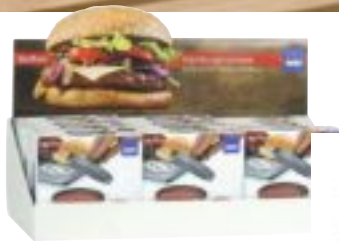

**Ab 12 Stück im Verkaufsdisplay**  
From 12 pieces in the customer attractive display.

A partir de 12 pièces dans un présentoir motivant.

L39,5 / T20 / H26,5

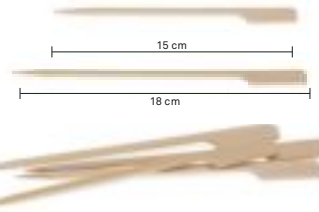

**Hamburger-Spieße Sunny**  
Hamburger skewers  
Piques pour hamburger

1 - 100

**12022** 4025457120220

1 - 100

**12023** 4025457120237

50 Stück · 50 pieces · 50 pièces

Bambus · Bamboo · Bambou

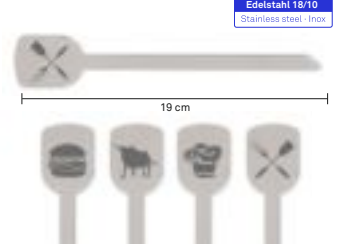

**Hamburger-Spieße Sammy**  
Hamburger skewers  
Piques pour hamburger

1 6 72

**19219** 4025457192197

18/10 Edelstahl · Stainless steel · Inox

4 verschiedene Motive

4 different shapes

4 motifs différents

**Gewachstes Antihafpapier sorgt für optimales Lösen der Patties**

Waxed for best extraction of the patties  
Ciré pour l'extraction optimale des steacks

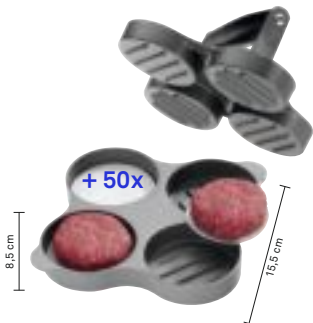

**Mini-Hamburgerpresse Buffalo**

Mini burger press  
Presse à hamburger mini

1 - 6

**11718** 4025457117183

Aluguss antihafbeschichtet  
Cast aluminum non-stick coating  
Revêtement antiadhésif en fonte d'aluminium

Hamburger 7 cm Ø

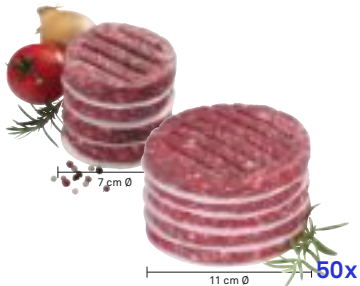

**Antihafpapier Buffalo**

Non-stick paper  
Papier anti-adhésif

1 12 144 For 11718

**11719** 4025457117190

1 12 144 For 11715

**11717** 4025457117176

50 Blatt · 50 Sheets · 50 Feuilles



# Küchenhelfer

Edelstahl glänzend  
Stainless steel bright  
Inox brillant



**Spätzleshobel Emma**  
Spaetzle maker · Mandoline à spaetzle

---

1 - 12

---

**19087** 4025457190872

---

18/10 Edelstahl · Stainless steel · Inox

**Spätzleshobel Emma**  
Spaetzle maker · Mandoline à spaetzle

---

1 - 12

---

**19088** 4025457190889

---

18/10 Edelstahl · Stainless steel · Inox

**Kartoffelpresse Hilde**  
Potato ricer · Presse-purée

---

1 - 12

---

**11217** 4025457112171

---

18/10 Edelstahl · Stainless steel · Inox

**Spaghetti- und Spätzleszange Fresh**  
Spaghetti tongs · Pince spaghetti

---

1 12 72

---

**19123** 4025457191237

---

18/10 Edelstahl · Stainless steel · Inox



**19087** Für kurze Spätzle  
For short spaetzle  
Pour des Spaetzle courts



**19088** Für lange Spätzle  
For long spaetzle  
Pour des Spaetzle longs

Auch als  
Flaschenöffner nutzbar  
Can also be used as  
a bottle opener  
Utilisable également  
comme  
ouvre-bouteilles



**Nussknacker Aki**  
Nutcracker · Casse noix

---

1 12 24

---

**10030** 4025457100307



# Kochen & Braten



## Punkto

Edelstahl 18/10  
Stainless steel 18/10  
Inox 18/10

Edelstahl 18/10  
Stainless steel · Inox



**Ab 15 Stück  
im Verkaufsdisplay**  
From 15 pieces  
in the customer attractive display.  
A partir de 15 pièces  
dans un présentoir motivant.  
L30,5 / T19 / H26,5



5 cm Ø	
<b>Fleischthermometer Punkto</b>	
Meat thermometer · Thermomètre à viande	
1 15 30	
<b>15315</b>	4025457153150
18/10 Edelstahl · Stainless steel · Inox	
0 - 120 °	



# Kochen & Braten

Kochhilfen  
Culinary aids  
Aides culinaires

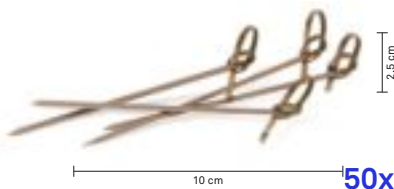

**Party-Spieße Sally**  
Party skewers · Pique Apéritif

1- 100

12021 4025457120213

Bambus · Bamboo · Bambou

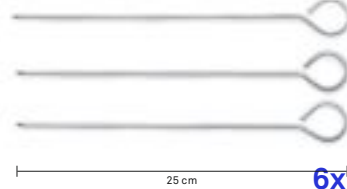

**Schaschlik-Spieße Pincho**  
Shashlik skewers · Pique brochettes

1 12 72

11214 4025457112140

Edelstahl · Stainless steel · Inox

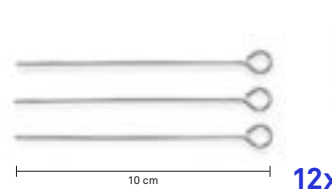

**Rouladennadeln Pincho**  
Roulades skewers · Piques à paupiettes

1 12 288

11212 4025457112126

Edelstahl · Stainless steel · Inox



**Rouladenringe Pincho**  
Roulade rings · Cerclage à paupiettes

1 12 144

11213 4025457112133

Verstellbar · Adjustable · Ajustable

Edelstahl · Stainless steel · Inox



Edelstahl 18/10  
Stainless steel · Inox



**Gemüsedämpfer Rosi**  
Vegetable steamer · Cuit vapeur

1 12 36

19099 4025457190995

Faltbar · Foldable · Pliable

Für Töpfe von: · Adjustable between:  
Ajustable: 14 - 24 cm Ø

18/10 Edelstahl · Stainless steel · Inox



Edelstahl 18/10  
Stainless steel · Inox



**Tee-/Gewürzkugel Aromi**  
Tea and spice infuser · Boule à thé/épices

1 12 96

11304 4025457113048

18/10 Edelstahl · Stainless steel · Inox



Edelstahl 18/10  
Stainless steel · Inox

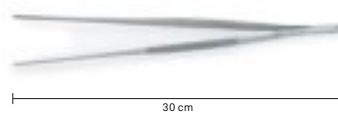

**Grill-/Bratenpinzette Pinca**  
Food tongs · Pince à aliment

1 24 144

11467 4025457114670

18/10 Edelstahl · Stainless steel · Inox

# Messerdisplays

30-teilig · Klinge Messerstahl · Griff PP-Kunststoff  
 30 pieces · Knifes steel · PP plastic handle  
 30 pièces · Lame acier · Poignée PP-plastique



30x

**Display Vespermesser Rapido**  
 Display kitchen knife  
 Display Couteaux

1 - 4

**11349** 4025457113499

5 Farben sortiert  
 5 assorted colours  
 5 coloris assortis

Display L26 cm / T23,5 / H26

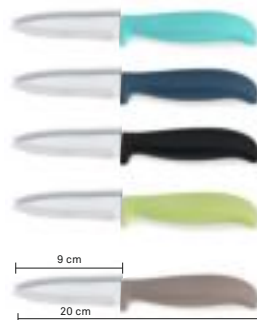

30x

**Display Küchenmesser Skarp**  
 Display kitchen knife  
 Display couteaux d'office

1 - 4

**11348** 4025457113482

5 Farben sortiert  
 5 assorted colours  
 5 coloris assortis

Display L26 cm / T22,5 / H26

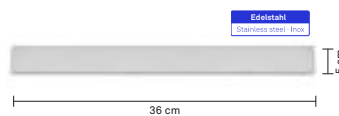

**Magnetleiste Plan**  
 Magnetic knife rack  
 Barre aimantée

1 6 12

**15715** 4025457157158

Edelstahl · Stainless steel · Inox

Matt · Matt · Mat

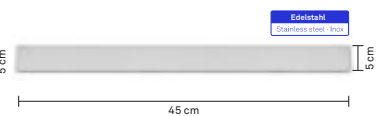

**Magnetleiste Plan**  
 Magnetic knife rack  
 Barre aimantée

1 5 10

**15716** 4025457157165

Edelstahl · Stainless steel · Inox

Matt · Matt · Mat

# Messerblock Acida

PP-Kunststoff mit Soft-touch · Messerstahl antihaftbeschichtet  
 PP plastic · Non-stick coated knife steel  
 PP-plastique · Lame acier anti-adhérent



Edelstahl  
 Stainless steel · Inox

Praktisches Innenleben aus vielen dünnen Kunststoff-Borsten. Diese verhindern, dass sich die Messer gegenseitig berühren und verkratzen. Die Messer lassen sich dabei an beliebigen Stellen positionieren. Außerdem kann man das Innenteil leicht herausnehmen, ausklopfen oder sogar in die Spülmaschine geben.

Practical inner consisting of multiple thin plastic rods. They prevent the blades from coming into contact with each other and becoming scratched. Position the knives at random. Simply remove the insides, tap them or even put them in the dishwasher.

Intérieur fait de petites tiges de résine, ce qui évite des rayures par frottement entre les couteaux. Les couteaux sont positionnables à souhait. L'intérieur est amovible et passe au lave vaisselle.



<b>Messerblock</b>	
Knife block · Bloc de couteaux	
1	- 4
<b>11286</b>	4025457112867
Weiß · White · Blanc	
6-teilig · 6 pieces · 6 pièces	



<b>Messerblock</b>	
Knife block · Bloc de couteaux	
1	- 4
<b>11288</b>	4025457112881
Grau · Grey · Gris	
6-teilig · 6 pieces · 6 pièces	



<b>Messerblock</b>	
Knife block · Bloc de couteaux	
1	- 4
<b>11287</b>	4025457112874
Schwarz · Black · Noir	
6-teilig · 6 pieces · 6 pièces	

# Küchenhelfer

Praktisches Zubehör  
 Practical accessories  
 Accessoires pratiques



<b>Mörser mit Stößel Punta</b>	
Pestle and mortar · Mortier avec pilon	
1	- 27
<b>11375</b>	4025457113758
Porzellan · Porcelain · Porcelaine	



<b>Geflügelschere Boca 10"</b>	
Poultry shears · Ciseaux volaille	
1	12 36
<b>15365</b>	4025457153655
Edelstahl · Stainless steel · Inox	
POM Griff · POM handle · Poignée POM	
Feststellbar	
Lockable · Système de blocage	
Schwarz · Black · Noir	



<b>Geflügelschere Pollo 9,5"</b>	
Poultry shears · Ciseaux volaille	
1	6 36
<b>11208</b>	4025457112089
18/10 Edelstahl · Stainless steel · Inox	
Feststellbar	
Lockable · Système de blocage	



<b>Wiegemesser Ganda</b>	
Chopping knife · Hachoir	
1	- 50
<b>10866</b>	4025457108662
Edelstahl · Stainless steel · Inox	
Griff PP-Kunststoff	
PP plastic handle · Poignée PP-plastique	
Schwarz · Black · Noir	

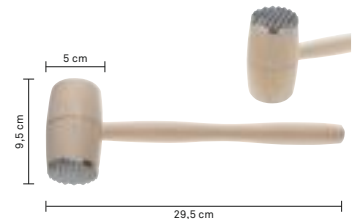

<b>Fleischklopper Maribor</b>	
Meat tenderiser · Attendrisseur	
1	- 12
<b>17302</b>	4025457173028
Buche · Beech · Hêtre	
Metallaufsatz auf einer Seite	
Metallic charge on one side	
Insert métallique sur un côté	

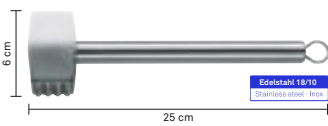

<b>Fleischklopper Noha</b>	
Meat tenderiser · Attendrisseur	
1	6 36
<b>11218</b>	4025457112188
18/10 Edelstahl · Stainless steel · Inox	



<b>Fleischklopper Pax</b>	
Meat tenderiser · Attendrisseur	
1	6 24
<b>11219</b>	4025457112195
18/10 Edelstahl · Stainless steel · Inox	
Mit Hackbeil · With cleaver · Avec bord tranchant	

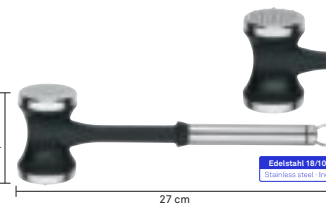

<b>Fleischklopper Lova</b>	
Meat tenderiser · Attendrisseur	
1	6 48
<b>11220</b>	4025457112201
18/10 Edelstahl · Stainless steel · Inox	
PP-Kunststoff · PP plastic · PP-plastique	
Schwarz · Black · Noir	



<b>4-Kant-Reibe Profi</b>	
4-sided grater · Râpe 4 faces	
1	12 72
<b>19065</b>	4025457190650
Edelstahl · Stainless steel · Inox	



# Pasta

Praktisches Zubehör  
Practical accessories  
Accessoires pratiques

## Walzen aus Chromstahl mit hochwertiger Oberflächenveredelung

Chromium steel rollers with high-grade finish

Rouleaux en acier chromé



Rutschfester Sockel  
Non-slip base  
Base anti dérapante

Extra hohe Tischklemme (7 cm)  
Ultra-high table clamp (7 cm)  
Pince réglable de table (7 cm)

Gehäuse: Chromstahl, Edelstahl Walzen: Chromstahl Teigbreite: 14,5 cm  
Teigdicke: 9 verschiedene Einstellungen von 0,3 mm bis 3 mm

Housing: Chrome + stainless steel,  
Rollers: Chrome-plated steel. Max. dough width: 14,5 cm  
Max. dough thickness: 9 different settings from 0.3 mm to 3 mm

Extérieur: Chrome et acier inoxydable,  
Rouleaux: acier chromé, Largeur de la pâte: 14,5 cm  
Épaisseur de la pâte: 9 possibilités 0,3 mm à 3 mm

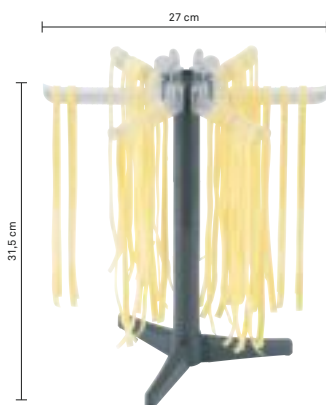

## Pastatrockner Adriana

Pasta dryer · Sècheur de pâte

1 - 30

11723 4025457117237

ABS-Kunststoff  
ABS plastic · ABS-plastique

Anthrazit · Anthracite · Anthracite



## Nudelmaschine Antonietta

Pasta maker · Machine à pâtes

1 - 4

11720 4025457117206

Für 3 Pasta-Sorten  
For 3 types of pasta  
Pour 3 sortes de pâtes



## Raviolivorsatz für Nudelmaschine 11720

Gehäuse: Chromstahl  
Walzen: ABS-Kunststoff  
mit Teigrandschneider  
Teigbreite: 10,5 cm  
Ravioligröße: 3 x 3 cm

Ravioli attachment for pasta machine 11720  
Housing: Chrome-plated steel  
Rollers: ABS with dough edge cutter  
Max. dough width: 10,5 cm  
Ravioli size: 3 x 3 cm

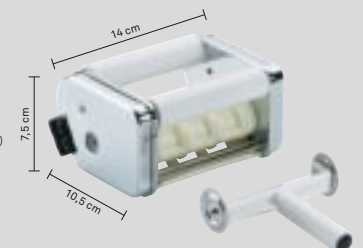

Moules à raviolis pour appareil 11720  
Extérieur: Acier chromé  
Rouleaux: ABS- plastique  
Avec découpe rebords  
Épaisseur de la pâte: 10,5 cm  
Dimension Raviolis: 3 x 3 cm

## Raviolivorsatz Antonietta

Ravioli Attachment  
Adaptateur pour Raviolis

1 - 12

11721 4025457117213

# Küchenhelfer

Edelstahl 18/10  
Stainless steel 18/10  
Inox 18/10



Edelstahl 18/10  
Stainless steel · Inox



**Dessertringe Decore**  
Dessert rings · Emporte-pièces

1	6	24	📦
<b>10785</b>	4025457107856		
3 Stück · 3 pieces · 3 pièces			



**Dessertringe Decore**  
Dessert rings · Emporte-pièces

1	6	60	📦
<b>10780</b>	4025457107801		
3-teilig · 3 pieces · 3 pièces			



**Dessertringe Decore**  
Dessert rings · Emporte-pièces

1	6	24	📦
<b>10781</b>	4025457107818		
3-teilig · 3 pieces · 3 pièces			



**Zitronenpresse Vision**  
Lemon squeezer · Presse-citron

1	-	36	📦
<b>19200</b>	4025457192005		



**Mehlsieb Frieda**  
Flour sifter · Tamis

1	6	60	📦
<b>19045</b>	4025457190452		



**Netzstreuer Rika**  
Mesh dredger · Saupoudreuse crépine

1	-	36	📦
<b>19170</b>	4025457191701		
Kunststoffdeckel Plastic cover · Couvercle plastifié			

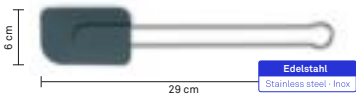

**Teigschaber Profi**  
Dough scraper · Spatule

1	12	96	📦
<b>11206</b>	4025457112065		
Silikon grau · Silicone grey · Silicone gris			
18/10 Edelstahl · Stainless steel · Inox			

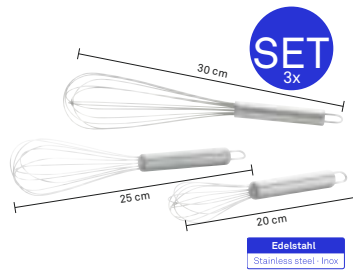

**Schneebesen-Set Senta**  
Egg whisk set · Set fouets

1	-	48	📦
<b>17908</b>	4025457179082		
3 Stück · 3 pieces · 3 pièces			
Edelstahl · Stainless steel · Inox			

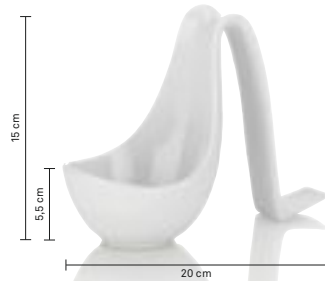

**Löffelablage Cuchara**  
Spoon holder · Repose cuillère

1	-	18	📦
<b>16945</b>	4025457169458		
Porzellan · Porcelain · Porcelaine			
Weiß · White · Blanc			



**Löffelablage Butler**  
Spoon holder · Repose cuillère

1	-	18	📦
<b>17906</b>	4025457179068		
Keramik · Ceramic · Céramique			
Metall verchromt Metal chromed · Métal chromé			
Weiß · White · Blanc			

# Digital-Küchenwaagen

LCD-Display · Inklusive Batterien

LCD display · Batteries included

LCD display Piles · Piles fournie

<b>0-5 kg</b>	<b>1g</b> Feinteilung Fine gauge · Précision	<b>Tara-Funktion</b> Tare function Fonction de tare	<b>LCD-Display</b> LCD-Display LCD-Display	<b>3 mm Sicherheitsglas</b> Safety glass Verre de sécurité	<b>1x CR2032 1,5 V</b>
---------------	--	---	--	--	------------------------

## Digital-Küchenwaagen Pinta

Digital kitchen scales · Balance digitale

1 - 20

**15727** 4025457157271

Opalgrau · Opal grey · Gris opal

**15740** 4025457157400

Weiß · White · Blanc

**15741** 4025457157417

Schwarz · Black · Noir

Glas · Glass · Verre



**Edelstahl**  
Stainless steel · Inox

## Design-Digitalküchenwaage Pia

Digital kitchen scales · Balance digitale

1 - 12

**15746** 4025457157462

Edelstahl · Stainless steel · Inox



## Tortencontainer

Casserole dish

Boîte de transport à Gâteau

- - 4\*

**12170** 4025457121708

Pastellblau · Pastel blue · Bleu pastel

**12173** 4025457121739

Dunkelgrau · Dark grey · Gris foncé



## Deli

PP-Kunststoff

PP plastic

PP-plastique



## Party-Butler

Party butler · Récipient à gâteau

- - 6\*

**12172** 4025457121722

Dunkelgrau · Darkgrey · Gris foncé



# Küchenhelfer

## Dry

PP-Kunststoff  
PP plastic  
PP-plastique



**Salatschleuder 4,3 L**  
Salad spinner · Essoreuse à salade  
1 - 12

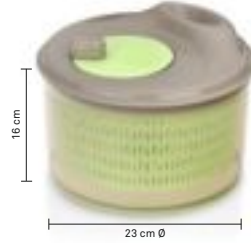

**12102** 4025457121029  
Pastellgrün / Opalgrau  
Pastel green / Opal grey  
Vert pastel / Gris opal



**12103** 4025457121036  
Pastellblau / Opalgrau  
Pastel blue / Opal grey  
Bleu pastel / Gris opal

## Mailin

PP-Kunststoff  
PP plastic  
PP-plastique



**Salatschleuder 4,4 L**  
Salad spinner · Essoreuse à salade  
1 - 6



**11906** 4025457119064  
Grün · Green · Vert



**11907** 4025457119071  
Grau · Grey · Gris

## Profi

Edelstahl 18/10  
Stainless steel 18/10  
Inox 18/10

**Edelstahl 18/10**  
Stainless steel · Inox



**Kaffeiesieb 8 cm Ø**  
Coffee sieve · Passoire à café  
1 10 100  
**19054** 4025457190544



**Küchensieb 10 cm Ø**  
Mesh colander · Passoire cuisine  
1 10 100  
**19055** 4025457190551

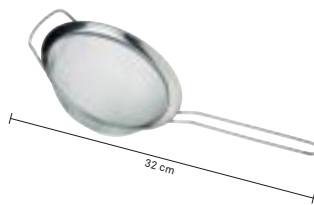

**Küchensieb 16 cm Ø**  
Mesh colander · Passoire cuisine  
1 6 72  
**19056** 4025457190568

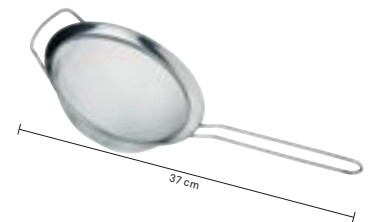

**Küchensieb 20 cm Ø**  
Mesh colander · Passoire cuisine  
1 6 36  
**19058** 4025457190582

**3x**

**Küchensieb-Set**  
Mesh sieve set · Set passoires cuisine  
1 - 8   
**11074** 4025457110740  
3 Stück · 3 pièces · 3 pièces  
8/14/20 cm Ø





# Schüsseln & Siebe

Edelstahl 18/10  
Stainless steel 18/10  
Inox 18/10

Edelstahl 18/10  
Stainless steel · Inox



## Athos

Außen matt, innen glänzend 0,7 mm  
Matt on the outside, polished on the inside, 0,7 mm  
Extérieur mat, intérieur brillant 0,7mm

## Kelos

Matt, 0,8 mm  
Matt, 0,8 mm  
Mat, 0,8 mm

## Mary

Matt, 0,5 mm  
Matt, 0,5 mm  
Mat, 0,5 mm



Küchensieb	
Strainer · Passoires de cuisine	
1 4 16	☐
B27,5 / H14,5 / Ø20	
11980	4025457119804
1 4 12	☐
B32,5 / H15,5 / Ø24	
11981	4025457119811



Schüssel	
Bowl · Jatte	
1 4 16	☐
H11 / Ø18	
11975	4025457119750
H13 / Ø20 cm	
11976	4025457119767
1 4 12	☐
H14 / Ø24	
11977	4025457119774
H16 / Ø26 cm	
11978	4025457119781



Schüssel	
Bowl · Jatte	
- 1 12	☐
H8,5 / Ø21	
11985	4025457119859
H9,5 / Ø24	
11986	4025457119866
H11 / Ø27	
11987	4025457119873
H12 / Ø30	
11988	4025457119880



Schüssel 3,5 L	
Bowl · Jatte	
1 - 6	☐
Kunststoffdeckel Plastic lid · Plastique couvercle	
Silikonboden Silicone base · Fond en silicone	
11699	4025457116995
Opalgrau · Opal grey · Gris opal	
11698	4025457116988
Schwarz · Black · Noir	

# Holzserie Katana

Bambus  
Bamboo  
Bambou



**Schneidebrett**  
Chopping board · Planche à découper  
1 - 24   
**11870** 4025457118708



**Schneidebrett**  
Chopping board · Planche à découper  
1 - 18   
**11871** 4025457118715



**Schneidebrett**  
Chopping board · Planche à découper  
1 - 12   
**11872** 4025457118722



**Käseglocke**  
Cheese cover · Cloche à fromage  
1 - 8   
**11874** 4025457118746

Deckel: Glas  
Cover: Glass  
Couvercle: Verre



**Schneidebrett-Set**  
Chopping board set · Set planche à découper  
1 - 8   
**12014** 4025457120145  
3-teilig · 3 pieces · 3 pièces



**Schneidebrett-Set**  
Chopping board set · Set planche à découper  
1 - 6   
**12009** 4025457120091  
20 x 15 cm, 1,5 cm h  
31 x 23 cm, 1,5 cm h  
38 x 29 cm, 1,5 cm h  
3-teilig · 3 pieces · 3 pièces



**Schneidebrett**  
Chopping board · Planche à découper  
1 - 8   
**12007** 4025457120077

Mit Safrille  
With juice groove  
Avec récupérateur de jus



**Schneidebrett**  
Chopping board · Planche à découper  
1 - 8   
**12008** 4025457120084

Mit Safrille  
With juice groove  
Avec récupérateur de jus



**Schneidebrett**  
Chopping board · Planche à découper  
1 - 6   
**11682** 4025457116827

Mit Safrille  
With juice groove  
Avec récupérateur de jus

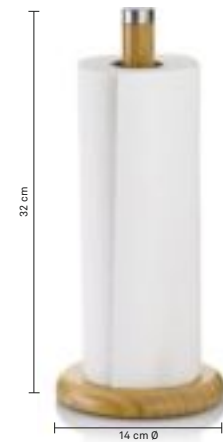

**Küchenrollenhalter**  
Kitchen roll holder · Support à essuie-tout  
1 - 12   
**11873** 4025457118739

# Schneidebretter

In unterschiedlichen Ausführungen

In different versions

Dans différentes versions



**Universalbrett Kiana**  
Universal board · Planche universelle

1 - 3   
12010 4025457120107

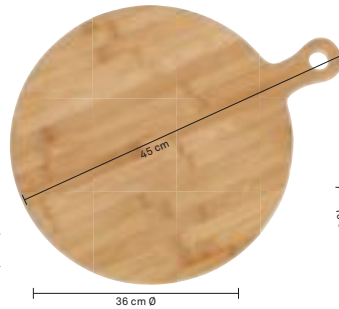

**Servierbrett Nino**  
Serving board · Planche

1 - 8   
12024 4025457120244



**Schneidebrett mit Messer Ida**  
Chopping board with knife  
Planche à découper avec couteau

- 8 32   
12020 4025457120206  
2-teilig · 2 pieces · 2 pièces

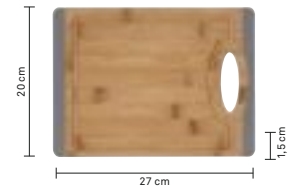

**Schneidebrett Gary**  
Chopping board · Planche à découper

1 - 12   
12300 4025457123009

Silikon Grau · Silicone Grey · Silicone Gris

Bambus  
Bamboo  
Bambou



**Schneidebrett-Set**  
Chopping board set · Planches à découper

1 - 12   
12025 4025457120251



**Schneidebrett**  
Chopping board · Planche à découper

1 - 12   
12026 4025457120268



**Schneidebrett**  
Chopping board · Planche à découper

1 - 12   
12027 4025457120275

Mina  
Buche  
Beech  
Hêtre



## Brettchenständer Almira

Birke  
Birch  
Bouleau

**Brettchen-Ständer 5-teilig**  
Small tray rack · Support de planchettes

1 - 6   
12047 4025457120473

# Universal- und Backbrett



**Beidseitig verwendbar**  
**Eine Seite mit Safrille**  
 Reversible - Utilisable des deux côtés  
 Un côté avec récupérateur de jus



<b>Universalbrett Kiana</b>	
Universal board · Planche universelle	
1	- 3
<b>11785</b>	4025457117855
Bambus · Bamboo · Bambou	



**Beidseitig verwendbar**  
 Reversible  
 Utilisable recto-verso



<b>Backbrett Kiana</b>	
Dough tray · Planche à pâtisserie	
1	- 3
<b>12006</b>	4025457120060
Bambus · Bamboo · Bambou	



**Beidseitig verwendbar**  
 Reversible  
 Utilisable recto-verso

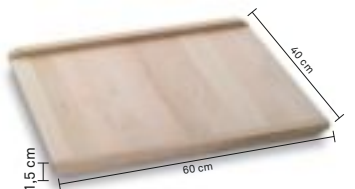
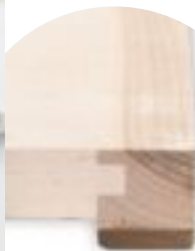

<b>Backbrett Almina</b>	
Dough tray · Planche à pâtisserie	
1	- 6
<b>12048</b>	4025457120480
Birke · Birch · Bouleau	

Schubladeneinteilung Kalma  
 Cutlery box Kalma  
 Range couverts Kalma

Seite/Page 106



12011



12012



12013





# Schneidebrett Leika

PP-Kunststoff  
PP plastic  
PP-plastique

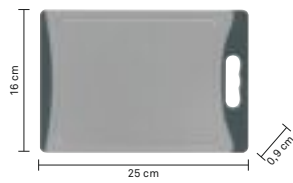

**Schneidebrett**  
Chopping board · Planche à découper

1	-	20	00
11420	4025457114205		
Grau · Grey · Gris			



**Schneidebrett**  
Chopping board · Planche à découper

1	-	12	00
11421	4025457114212		
Grau · Grey · Gris			



**Schneidebrett**  
Chopping board · Planche à découper

1	-	12	00
11422	4025457114229		
Grau · Grey · Gris			









# ***Auftischen mit Stil***

Serve with style

Table stylée

# Espressokannen

Klassisch und gut  
Classic and good



## Latina

18/10 Edelstahl · Unterteil Edelstahl · Induktionsfähig  
18/10 Stainless steel · Stainless steel base · Induction hobs  
18/10 Inox · Dessous en acier inoxydable · Compatible induction



Edelstahl  
Stainless steel · Inox

Edelstahl 18/10  
Stainless steel · Inox

Glänzend  
Bright  
Brillant



Espressokanne 200 ml  
Espresso maker · Percolateur

1 - 12

10835 4025457108358



Espressokanne 300 ml  
Espresso maker · Percolateur

1 - 12

10836 4025457108365

## Bari

18/10 Edelstahl · Unterteil Edelstahl · Induktionsfähig  
18/10 Stainless steel · Stainless steel base · Induction hobs  
18/10 Inox · Dessous en acier inoxydable · Compatible induction



Edelstahl  
Stainless steel · Inox

Edelstahl 18/10  
Stainless steel · Inox

Glänzend  
Bright  
Brillant



Espressokanne 250 ml  
Espresso maker · Percolateur

1 6 12

10600 4025457106002



Espressokanne 350 ml  
Espresso maker · Percolateur

1 6 12

10601 4025457106019

## Italia

Aluminium  
Aluminium  
Aluminium



Espressokanne 150 ml  
Espresso maker · Percolateur

1 - 30

10590 4025457105906



Espressokanne 300 ml  
Espresso maker · Percolateur

1 - 20

10591 4025457105913



Espressokanne 450 ml  
Espresso maker · Percolateur

1 - 10

10592 4025457105920



Ersatzdichtung Bella  
Replacement gasket  
Joint souple de rechange

1 100 500

10584 4025457105845

1 100 500

10585 4025457105852

1 100 500

10586 4025457105869

Für · For · Pour: Latina, Bari, Italia





# Kaffeebereiter

Mit Kaffeepress-System  
Coffee pressing system  
Cafetière à piston

## Roma

Borosilikat Glas hitzebeständig · Siebeinsatz Edelstahl 18/10 · Schwarzer Kunststoff  
Borosilicate glass heat resistant · Infuser: 18/10 stainless steel · Black plastic  
Verre borosilicate résistant à la chaleur · Filtre: 18/10 Inox · Plastique noir



**Kaffeebereiter 600 ml**  
Coffee maker · Cafetière à piston  
1 - 12

10848 4025457108488



**Kaffeebereiter 1,0 L**  
Coffee maker · Cafetière à piston  
1 - 12

10849 4025457108495



Edelstahl 18/10  
Stainless steel · Inox

## Venecia

Glas hitzebeständig · Siebeinsatz Edelstahl 18/10 · Deckel und Halter Edelstahl  
Glass heat resistant · Infuser: 18/10 stainless steel · Stainless steel lid and holder  
Verre résistant à la chaleur · Filtre: 18/10 Inox · Couvercle et support en inox



**Kaffeebereiter 600 ml**  
Coffee maker · Cafetière à piston  
1 - 12

10851 4025457108518



**Kaffeebereiter 1,0 L**  
Coffee maker · Cafetière à piston  
1 - 12

10852 4025457108525



Edelstahl  
Stainless steel · Inox

Edelstahl 18/10  
Stainless steel · Inox



**Milchkrug Herta 350 ml**  
Milk cup · Broc à lait  
1 - 24

10900 4025457109003

Glänzend · Bright · Brillant



**Milchkrug Herta 700 ml**  
Milk cup · Broc à lait  
1 - 12

10901 4025457109010

Glänzend · Bright · Brillant



**Display Milchaufschäumer Maito**  
Milk frother display · Display mousseurs à lait

1 - 8

11495 4025457114953

ABS-Kunststoff  
ABS plastic · ABS-plastique

18/10 Edelstahl · Stainless steel · Inox

Batteriebetrieben · Ohne Batterie  
Battery operated · Batteries not included  
Alimenté par pile · Sans piles

Schwarz · Black · Noir

# Vinci & Cesena

Warmer Kaffee und angenehm kühle Außenwände durch doppelwandiges Borosilikatglas

Hot coffee and pleasantly cool side walls, thanks to double-walled glass jug

Le café reste chaud tandis que la double paroi en verre reste agréablement froide



Warm  
oder kalt

## Cesena 2x

### Espressoglas 80 ml

Espressoglass · Verre Espresso

1 - 24 H6,5 / Ø6 cm

12410 4025457124105

### Cappuccinoglas 200 ml

Cappuccinoglass · Verre Cappuccino

1 - 24 H8,5 / Ø8 cm

12411 4025457124112

### Latte Macchiato Glas 300 ml

Lattemacchiatoglass · Verre Latte Macchiato

1 - 24 H12 / Ø8,5 cm

12412 4025457124129



17,5 cm

7,5 cm Ø

### Kaffeebereiter Vinci 350 ml

Coffee maker · Cafetière à piston

1 - 12

10807 4025457108075



22 cm

10 cm Ø

### Kaffeebereiter Vinci 950 ml

Coffee maker · Cafetière à piston

1 - 12

10808 4025457108082

# Teekannen

Siebeinsatz 18/10 Edelstahl · Alle Teekannen sind mit herausnehmbarem Siebeinsatz  
 18/10 stainless steel infuser · Tea infuser removable  
 Filtre en inox 18/10 · Filtre à thé amovible



**Teekanne 0,9 L**  
 Teapot · Théière

1 - 6

**11355** 4025457113550

Glänzend · Bright · Brillant



**Teekanne 1,7 L**  
 Teapot · Théière

1 - 6

**11356** 4025457113567

Glänzend · Bright · Brillant



## Ancona

Edelstahl 18/10  
 Stainless steel 18/10  
 Inox 18/10

Edelstahl 18/10  
 Stainless steel · Inox

## Auron

Borosilikat-Glas hitzebeständig · PP-Kunststoff · Schwarz  
 Borosilicate glass heat resistant · PP plastic · Black  
 Verre borosilicate: résistant à la chaleur · PP-plastique · Noir



**Teekanne 0,7 L**  
 Teapot · Théière

1 - 12

**11457** 4025457114571



**Teekanne 1,0 L**  
 Teapot · Théière

1 - 12

**11458** 4025457114588



Abnehmbarer Kunststoffring  
 Plastic ring removable  
 Le socle en plastique amovible

# Wasserkessel Varus

Edelstahl 18/10 · Induktionsboden

Kettle · Stainless steel 18/10 · Induction base

Bouilloire · Inox 18/10 · Avec fond induction

Edelstahl 18/10  
Stainless steel · Inox



Wasserkessel 3,0 L  
Kettle · Bouilloire

1 - 12

11655 4025457116551

Silber · Silver · Argent



Opalgrau · Opal grey · Gris opal

11697 4025457116971



Schwarz · Black · Noir

11656 4025457116568



Weiß · White · Blanc

11657 4025457116575



Rot · Red · Rouge

11658 4025457116582

## Tee-/Gewürzkugeln

Edelstahl 18/10

Stainless steel 18/10

Inox 18/10

Edelstahl 18/10  
Stainless steel · Inox

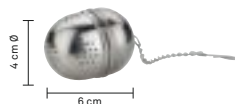

Tee Ei Vision 4 cm Ø

Tea egg · Boule à thé

1 12 144

15314 4025457153143



Tee-/Gewürzkugel Profi

Tea and spice ball · Boule à thé/épices

1 12 576 5 cm Ø

19051 4025457190513

1 12 288 6 cm Ø

19052 4025457190520

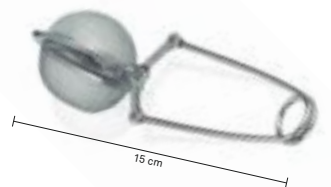

Tee-/Gewürzzange Profi

Tea and spice tongs · Pince à thé/épices

1 12 288 4,5 cm Ø

19050 4025457190506

1 12 288 6 cm Ø

19043 4025457190438

## Tee-Box Early

PS-Kunststoff · Mit 6 Fächern

PS plastic · With 6 compartments

PS-plastique · Avec 6 compartiments



Tee-Box

Tea Box · Boîte pour le thé

1 - 12

11999 4025457119996





# Teekannen

Borosilikat-Glas hitzebeständig · Alle Teekannen sind mit herausnehmbarem Siebeinsatz · Siebeinsatz 18/10 Edelstahl · Deckel Edelstahl  
 Borosilicate glass heat resistant · Tea infuser removable · 18/10 stainless steel infuser · Stainless steel lid  
 Verre borosilicate: résistant à la chaleur · Filtre à thé amovible · Filtre en inox 18/10 · Couvercle Inox

**Edelstahl**  
 Stainless steel · Inox

**Edelstahl 18/10**  
 Stainless steel · Inox



**Teekanne 1,3 L**  
 Teapot · Thêière

1 - 12

**16940** 4025457169403



**Teekanne 1,8 L**  
 Teapot · Thêière

1 - 12

**16941** 4025457169410



**Aurora**  
 Deckel Matt  
 Lid Matt  
 Couvercle Mat

Verbessertes  
 Ausgießverhalten



**Teekanne 1,2 L**  
 Teapot · Thêière

1 - 12

**16922** 4025457169229



**Teekanne 1,5 L**  
 Teapot · Thêière

1 - 12

**11456** 4025457114564



**Cylon**  
 Deckel matt  
 Lid matt  
 Couvercle mat



**Teekanne 0,7 L**  
 Teapot · Thêière

1 - 12

**10837** 4025457108372



**Teekanne 1,5 L**  
 Teapot · Thêière

1 - 8

**10838** 4025457108389



**Ariana**  
 Deckel glänzend  
 Lid bright  
 Couvercle brillant

# Wasserkaraffe & Saftkrug

Glas  
Glass  
Verre



**Kippdeckel für einfaches Ausgießen**  
Tipping lid for easy pouring  
Bouchon à bascule pour un service impeccable



**Wasserglas-Set Fontana 250 ml**  
Water glass · Verre à eau

1	-	24	📦
<b>12417</b>	4025457124174		



**Wasserkaraffe Fontana 1,3 L**  
Water carafe · Carafe à eau

1	-	9	📦
<b>12416</b>	4025457124167		
18/10 Edeltahl · Stainless steel · Inox			



**Wasserkaraffe / Gläser Fontana**  
Water carafe/ Water glasses  
Carafe à eau/ Verres à eau

1	-	4	📦
<b>12415</b>	4025457124150		
18/10 Edeltahl · Stainless steel · Inox			



**Öffnung im Deckel - für ein einfaches Ausgießen.**

The hole in the lid ensures simple pouring.

Le trou dans le couvercle permet de verser facilement.



**Saftkrug Pitcher 1,0 L**  
Juice jug · Pichet à jus

1	-	12	📦	1,0 L
<b>11397</b>	4025457113970			
Edeltahl · Stainless steel · Inox				



**Saftkrug Pitcher 1,6 L**  
Juice jug · Pichet à jus

1	-	12	📦	1,6 L
<b>11398</b>	4025457113987			
Edeltahl · Stainless steel · Inox				



**Saftkrug 1,5 L Fontana**  
Juice jug · Carafe à jus

1	-	9	📦
<b>12418</b>	4025457124181		
18/10 Edeltahl · Stainless steel · Inox			

# Krüge und Karaffen

Glas  
Glass  
Verre

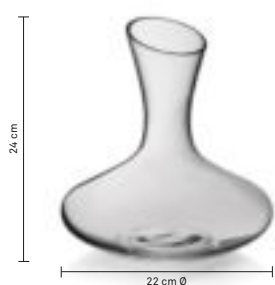

**Wein-Dekantierkaraffe Lorena 1,7 L**  
Wine decanter carafe  
Carafe à décanter le vin

1	-	6	📦
<b>12151</b>		4025457121517	



**Wein-Dekantierkaraffe Francesca 1,7 L**  
Wine decanter carafe  
Carafe à décanter le vin

1	-	6	📦
<b>12150</b>		4025457121500	



**Saft-/Wasserkrug Roberta 1,0 L**  
Juice-/water jug  
Pichet à jus de fruits – Pichet à eau

1	-	12	📦
<b>12154</b>		4025457121548	

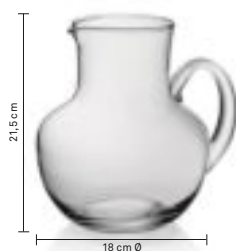

**Saft-/Wasserkrug Bianca 2,5 L**  
Juice-/water jug  
Pichet à jus de fruits – Pichet à eau

1	-	6	📦
<b>12153</b>		4025457121531	



**Saft-/Wasserkrug Antonia 1,7 L**  
Juice-/water jug  
Pichet à jus de fruits – Pichet à eau

1	-	9	📦
<b>12155</b>		4025457121555	



**Saft-/Wasserkrug Sofia 1,8 L**  
Juice-/water jug  
Pichet à jus de fruits – Pichet à eau

1	-	8	📦
<b>12152</b>		4025457121524	



# Glanzvoll servieren

## Pascal

Edelstahl 18/10  
Stainless steel 18/10  
Inox 18/10

Edelstahl 18/10  
Stainless steel · Inox

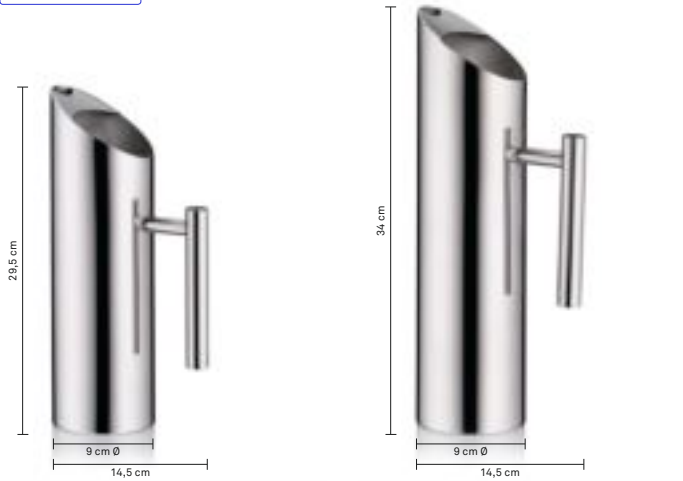

Saft-/ Wasserkrug 1,2 L  
Juice/water jug  
Cruche à jus de fruits/Cruche à eau

1 - 6

12164 4025457121647

Saft-/ Wasserkrug 1,5 L  
Juice/water jug  
Cruche à jus de fruits/Cruche à eau

1 - 6

12165 4025457121654



## Prato

Edelstahl 18/10  
Stainless steel 18/10  
Inox 18/10

Edelstahl 18/10  
Stainless steel · Inox

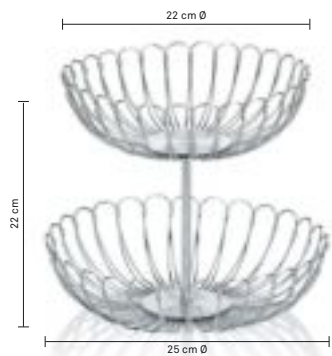

Etagere  
Baskets · Etagère à fruits

1 - 8

11497 4025457114977

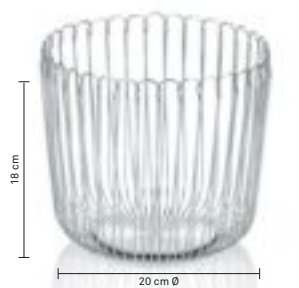

Fruchtkorb  
Fruit basket · Corbeille à fruits

1 - 8

11498 4025457114984



Fruchtkorb  
Fruit basket · Corbeille à fruits

1 - 16

11499 4025457114991



# Salz- & Pfeffermühlen

Mühen  
Mills  
Moulines



## CrushGrind®



CrushGrind® 25:  
powerful and precise  
multi-purpose ceramic grinder

- Resistant to abrasion and corrosion
- Grinding coarseness can be individually adjusted
- Easy filling from the top
- Easy to clean

CrushGrind® 25:  
kraftvolles und präzises  
Keramik-Mehrweckmahlwerk

- Abrieb- und korrosionsfrei
- Mahlgrad individuell einstellbar
- Einfache Befüllung von oben
- Leicht zu reinigen

CrushGrind® 25:  
broyeur céramique polyvalent  
puissant et précis

- Résistance à l'usure et à la corrosion
- Degré de broyage réglable
- Remplissage facile depuis le haut
- Entretien facile



Auch nutzbar  
als Gewürzmühle  
Can also be used as  
a spice mill  
Peut être utilisé  
également comme  
moulin à épices

Salz-/Pfeffermühle Kaja	
Salt and pepper mill · Moulin à sel & poivre	
1	- 16
11786	4025457117862
11787	4025457117879
11788	4025457117886
Akazienholz · Acacia · Acacia	

### Mühen mit Keramikmahlwerk Mills with ceramic grinder Moulines avec broyeur céramique

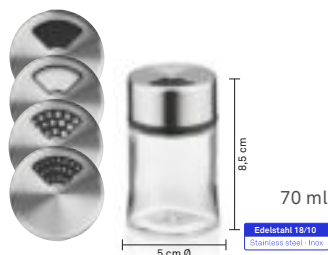

**Display Multistreuer Manolo**  
Display Multi purpose shaker  
Display Saupoudreuse multi-usages

12*	48
11618	4025457059599
Glas · Glass · Verre	
Display L20 cm / B20T / H21,5H	



**Salzstreuher Sel**  
Salt pourer  
Salière

-	12* 144
12255	4025457122552
Glas · Glass · Verre	



**Salz-/Pfeffermühle Matteo**  
Salt and pepper mill display  
Display Moulin sel & poivre

-	8* 32
11619	4025457116193
Glas · Glass · Verre	
Rutschfester Ring Non slip ring · Anneau anti-dérapante	
Display L24,5 cm / B13 / H20,5	

4X Pastelltürkis · 4X Opalgrau  
4X Pastel turquoise · 4X Opal grey  
4X Turquoise pastel · 4X Gris opal



**Salz-/Pfeffermühle Molino**  
Salt and pepper mill display  
Display Moulin sel & poivre

-	8* 32
11665	4025457116650
Glas · Glass · Verre	
Display L30 cm / B15 / H21,5	

# Abdeckhauben & Fruchtfliegenfallen

Extra kleine Löcher –  
Innen mit Draht verstärkt  
Extra small holes –  
Inside reinforced with wire  
Grillage de protection extra fin –  
Intérieur renforcé par du fil de fer



**Abdeckhaube Cara**  
Cover · Couvre plat  
1 - 24  
**11475** 4025457114755



**Abdeckhaube Cara**  
Cover · Couvre plat  
1 6 24  
**11444** 4025457114441

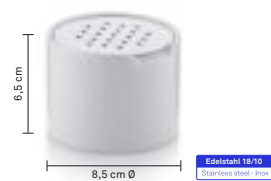

**Fruchtfliegenfalle Fino**  
Fruit fly trap · Piège à moucheron  
1 - 24  
**11900** 4025457119002  
Keramik · Ceramic · Céramique  
Weiß · White · Blanc



**Fruchtfliegenfalle Fino**  
Fruit fly trap · Piège à moucheron  
1 - 24  
**11901** 4025457119019  
Keramik · Ceramic · Céramique  
Hellgrau · Light grey · Gris clair

## Como

Metall farbig beschichtet  
Metal colour coated  
Métal revêtement couleur



**Abdeckhaube Como**  
Cover · Couvre plat  
1 - 24  
**11447** 4025457114472  
Grau · Grey · Gris



**Abdeckhaube Como**  
Cover · Couvre plat  
1 - 24  
**11448** 4025457114489  
Grün · Green · Vert

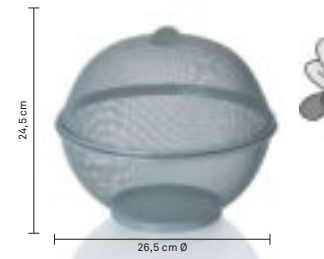

**Fruchtkorb Como**  
Fruit basket · Corbeille à fruits  
1 - 12  
**11449** 4025457114496  
Grau · Grey · Gris



**Fruchtkorb Como**  
Fruit basket · Corbeille à fruits  
1 - 12  
**11450** 4025457114502  
Grün · Green · Vert

## Drahtartikel

Metall verchromt  
Metal chromed  
Métal chromé

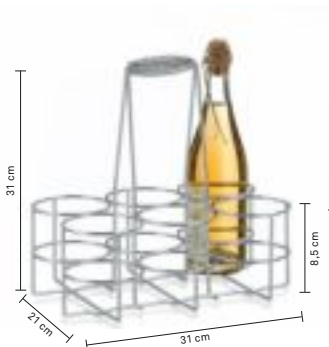

**Flaschenträger Loop**  
Bottle holder · Porte-bouteilles  
1 - 10  
**49880** 4025457498800

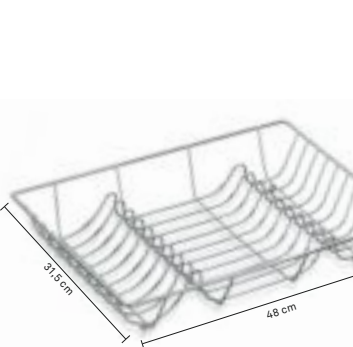

**Geschirrabtropfkorb Loop**  
Draining rack · Egottoir à vaisselle  
1 - 12  
**49553** 4025457495533

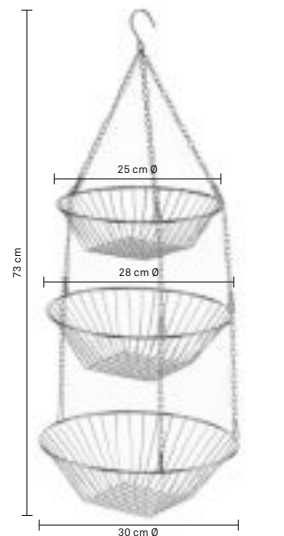

**Drahtetagere Loop**  
Hanging baskets · Etagère à paniers  
1 - 12  
**49552** 4025457495526

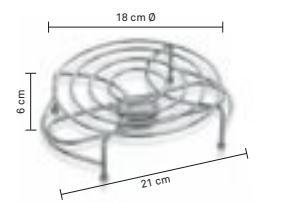

**Stövchen Globul**  
Teapot warmer · Chauffe-plat  
1 - 24  
**17600** 4025457176005  
Ohne Teelicht · Without tealight  
Sans bougie chauffe-plat

# Servieren am Tisch



**Butterdose Vision**  
Butter dish · Beurrier

1 6 60

**19243** 4025457192432



**Eierschneider Vision**  
Egg slicer · Trancheur à œuf

1 12 72

**19092** 4025457190926



**Eierbecher-Set Vision**  
Egg cups · Coquetiers

1 12 48

**19246** 4025457192463

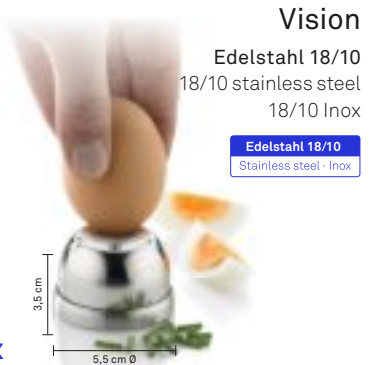

**Vision**  
Edelstahl 18/10  
18/10 stainless steel  
18/10 Inox

**Ei-Pick Vision**  
Egg pick · Pic à œuf

1 12 240

**19245** 4025457192456



**Butterdose Baldo**  
Butter dish · Beurrier

1 - 24

**11466** 4025457114663

MS-Kunststoff  
MS plastic · MS-plastique

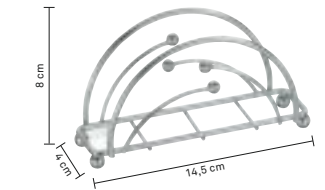

**Serviettenhalter Globul**  
Napkin holder · Porte-serviettes

1 - 48

**17550** 4025457175503

Metall verchromt  
Metal chromed · Métal chromé



**Eierbecher-Set Globul**  
Egg cups · Set coquetiers

1 - 12

**17580** 4025457175800

Metall verchromt  
Metal chromed · Métal chromé



**24/26 cm Ø** **2x**

**Untersetzer-Set Amparo**  
Coaster set · Set dessous de plat

- 12\* 36

**11651** 4025457116513

Filz · Felt · Feutre 4 mm

1x Grau · 1x Grün  
1x Grey · 1x Green  
1x Gris · 1x Vert

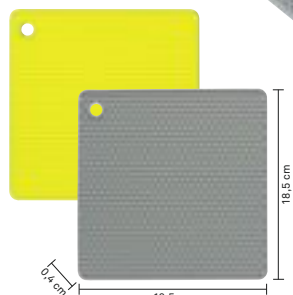

**Untersetzer Alida**  
Trivet · Dessous de plat

1 - 50

**11848** 4025457118487

Grün · Green · Vert

**11849** 4025457118494

Grau · Grey · Gris

Silikon · Silicone · Silicone

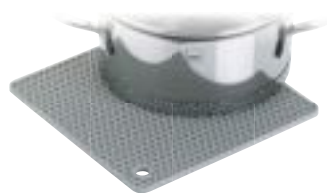

**Untersetzer Mina**  
Trivet · Dessous de plat

1 - 24

**12028** 4025457120282

Buche · Beech · Hêtre

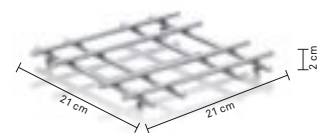

**Untersetzer Caro**  
Table protector · Dessous de plat

1 - 12

**12235** 4025457122354

Metall verchromt  
Metal chromed · Métal chromé

# Servieren am Tisch

Serving at the table  
Servir à la table

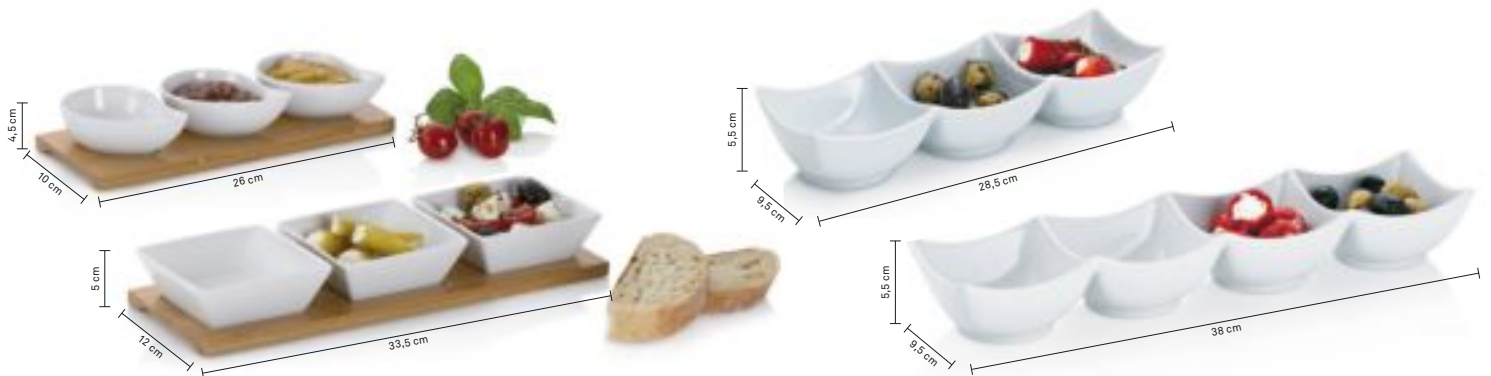

**Schalen-Set Philipa**  
Bowl set · Set coupelles

1	-	12	📦
<b>12260</b>	4025457122606		
Porzellan · Porcelain · Porcelaine			
Bambus · Bamboo · Bambou			
4-teilig · 4 pieces · 4 pièces			
Runde Form · Round shape · Forme ronde			

**Schalen-Set Philipa**  
Bowl set · Set coupelles

1	-	6	📦
<b>12261</b>	4025457122613		
Porzellan · Porcelain · Porcelaine			
Bambus · Bamboo · Bambou			
4-teilig · 4 pieces · 4 pièces			
Eckige Form Angular shape · Forme angulaire			

**Schalen-Trio Petit**  
Bowls · Coupelles

1	-	18	📦
<b>10752</b>	4025457107528		
Porzellan · Porcelain · Porcelaine			

**Schalenplatte Petit**  
Bowls · Coupelles

1	-	16	📦
<b>10758</b>	4025457107580		
Porzellan · Porcelain · Porcelaine			



**Käseglocke Petit**  
Cheese cover · Cloche à fromage

1	-	8	📦
<b>10746</b>	4025457107467		
Porzellan · Porcelain · Porcelaine			
Deckel: Glas · Lid: Glass · Couvercle: Verre			



**Käseglocke Petit**  
Cheese cover · Cloche à fromage

1	-	4	📦
<b>10747</b>	4025457107474		
Porzellan · Porcelain · Porcelaine			
Deckel: Glas · Lid: Glass · Couvercle: Verre			



**Käsehobel mit Haube Planum**  
Cheese scraper · Girolle à fromage

1	-	6	📦
<b>77080</b>	4025457770807		
Edelstahl · Stainless steel · Inox			
Klinge Edelstahl 18/10			
Buche · Beech · Hêtre			
AS-Kunststoff · AS plastic · AS-plastique			



**Glashaube Luxus**  
Glass cover · Couvercle en verre

1	-	6	📦
<b>17651</b>	4025457176517		
Glas · Glass · Verre			
Zu Käsehobel: 77085 Use with cheese scraper: 77085 Pour girolle à fromage: 77085			

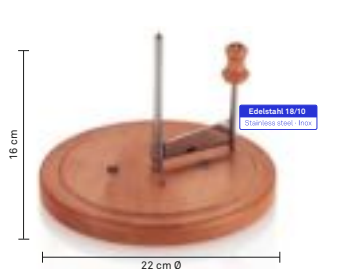

**Käsehobel Luxus**  
Cheese scraper · Girolle à fromage

1	-	12	📦
<b>77085</b>	4025457770852		
Edelstahl · Stainless steel · Inox			
Klinge Edelstahl 18/10			
Buche · Beech · Hêtre			



# *Genießen und sich Zeit gönnen*

Savour and take your time

Savourer et prendre son temps



# Raclette/Grillplatte/Heißer Stein

Elektrisch  
Electric  
Electrique

220 - 240 V / - 50 - 60 Hz



**Stufenlos regulierbar mit Kontrolllampe**  
Infinitely adjustable temperature controller with operating light  
Thermostat à réglage continu



**Kippschalter EIN-AUS mit Kontrolllampe**  
ON-OFF rocker switch, with operating light  
Interrupteur à bascule marche arrêt, avec le témoin lumineux rouge



## Raclette/Heißer Stein Ceneri

Raclette/ Hot stone

Raclette/Plaque de pierre chaude **66663** 4025457666636 1 - 2

a Granit · Granite · Granit

b Stahl antihaftbeschichtet · Non-stick coated steel · Acier antiadhésif

c Nylon · Nylon · Nylon

Schwarz · Black · Noir

1 m: VDE-Kabel · VDE cable · Câble VDE

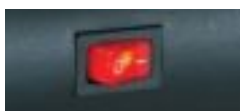

**Kippschalter EIN-AUS mit Kontrolllampe**  
ON-OFF rocker switch, with operating light  
Interrupteur à bascule marche arrêt, avec le témoin lumineux rouge



## Raclette/Grillplatte Bernina

Raclette/Grill plate

Raclette/Plaque de grill **66490** 4025457664908 1 - 8

a Stahl antihaftbeschichtet · Non-stick coated steel · Acier antiadhésif

b Nylon · Nylon · Nylon

Schwarz · Black · Noir

1 m: VDE-Kabel · VDE cable · Câble VDE



## Raclette/Heißer Stein Livigno

Raclette/ Hot stone

Raclette/Plaque de pierre chaude **66661** 4025457666612 1 - 3

a Granit · Granite · Granit

b Stahl antihaftbeschichtet · Non-stick coated steel · Acier antiadhésif

c Nylon · Nylon · Nylon

Schwarz · Black · Noir

1 m: VDE-Kabel · VDE cable · Câble VDE



## Raclette/Heißer Stein Splügen

Raclette/ Hot stone

Raclette/Plaque de pierre chaude **66493** 4025457664939 1 - 6

a Granit · Granite · Granit

b Stahl antihaftbeschichtet · Non-stick coated steel · Acier antiadhésif

c Nylon · Nylon · Nylon

Schwarz · Black · Noir

1 m: VDE-Kabel · VDE cable · Câble VDE



# Raclette

Elektrisch für 8 Personen  
Classic and good



230 V / - 50 - 60 Hz

**Stufenlos regulierbar mit Kontrolllampe**  
Infinitely adjustable temperature  
controller with operating light  
Thermostat à réglage continu



1000 W



**Raclettepfännchen Chalet**  
Raclette pan · Raclette pôele

1 8 30

**64010** 4025457640100

Aluguss antihafbeschichtet  
Cast aluminium non-stick coated  
Fonte d'aluminium antiadhésif

Schwarz · Black · Noir

**Raclette/Grillplatte Chalet**  
Raclette/Grill plate  
Raclette/Plaque de grill

**64002** 4025457640025 1 - 2

a Aluguss antihafbeschichtet · Cast aluminium non-stick coated · Fonte d'aluminium antiadhésif  
b Stahl antihafbeschichtet · Non-stick coated steel · Acier antiadhésif  
c Kunststoff · Plastic · Plastique

Schwarz · Black · Noir

1 m: VDE-Kabel · VDE cable · Câble VDE



## Zubehör

**NICHT für 64002 geeignet**  
**NICHT für 64002 geeignet**  
**NICHT für 64002 geeignet**



**Raclettepfännchen Juri**  
Raclette pan · Raclette pôele

1 - 40

**66496** 4025457664960

Stahl antihafbeschichtet  
Non-stick coated steel  
Acier antiadhésif

Schwarz · Black · Noir



**Raclettespatel Pillon**

Raclette spatulas · Spatules à raclette

1 24 48

**66667** 4025457666674

8-teilig · 8 pieces · 8 pièces

Nylon · Nylon · Nylon

Schwarz · Black · Noir



**Raclettespatel Arbon**

Raclette spatula · Spatules à raclette

1 - 140

**77033** 4025457770333

8-teilig · 8 pieces · 8 pièces

Buche · Beech · Hêtre



**Raclette-Brettchen Baar**

Raclette boards · Planchettes à raclette

1 - 48

**77937** 4025457779374

4-teilig · 4 pieces · 4 pièces

Buche · Beech · Hêtre



# Elektrogeräte

Raclette- und Grillvergnügen in vielen Variationen  
Versatile raclette and barbecue enjoyment  
Raclette et Grill dans diverses variations

230 V / - 50 - 60 Hz



**Stufenlos regulierbar mit Kontrolllampe**  
Infinitely adjustable temperature controller with operating light  
Thermostat à réglage continu



Topf  
induktionsfähig  
Pot inductionnable  
Casserole inductionnable

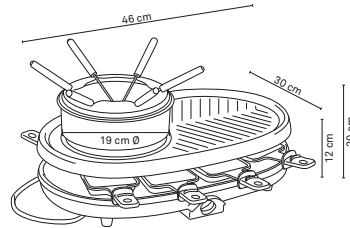

## Raclette, Grill und Fondue-Set Bernardino

Raclette, grill and fondue set  
Raclette, Grill et Service à fondue **66664** 4025457666643 1 - 2

- a 0,8 mm: Stahl antihafbeschichtet · Non-stick coated steel · Acier antiadhésif
- b Stahl antihafbeschichtet · Non-stick coated steel · Acier antiadhésif
- c Nylon · Nylon · Nylon
- d Kunststoff · Plastic · Plastique
- e Edelstahl · Stainless steel · Inox

Für ca. 1-1,2 L Öl oder Brühe  
For approx. 1-1.2 l oil or stock  
Pour environ 1-1.2 L d'huile ou de bouillon

Schwarz · Black · Noir

1 m: VDE-Kabel · VDE cable · Câble VDE



Topf · Pot · Caquelon

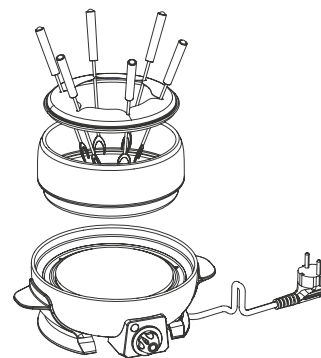

## Elektrofondue-Set Simplon

Electric fondue-set  
Service à fondue électro **66665** 4025457666650 1 - 4

- a 0,8 mm: Stahl antihafbeschichtet · Non-stick coated steel · Acier antiadhésif
- b Edelstahl · Stainless steel · Inox
- c Kunststoff · Plastic · Plastique
- d Aluminium Heizplatte · Aluminium heating plate · Plateau chauffant en aluminium

Für ca. 1-1,4 L Öl oder Brühe  
For approx. 1-1,4 l oil or stock  
Pour environ 1-1,4 L d'huile ou de bouillon

1 m: VDE-Kabel · VDE cable · Câble VDE





# Mini-Raclette Solo

Metall farbig beschichtet  
Colour-coated metal  
Métal revêtement couleur

**Ohne Teelicht**  
Without tealight / Sans bougie chauffe-plat

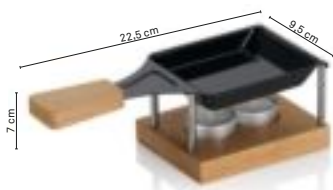

**Mini-Raclette**  
Mini Raclette · Mini raclettes

1 - 12   
**12500** 4025457125003

Buche · Beech · Hêtre



**Mini-Raclette**  
Mini Raclette · Mini raclettes

1 - 12   
**12501** 4025457125010

Akazie · acacia · acacia



**Mini-Raclette**  
Mini Raclette · Mini raclettes

1 - 12   
**12502** 4025457125027

Hellgrau · Light gray · Gris clair



**Mini-Raclette**  
Mini Raclette · Mini raclettes

1 - 12   
**12503** 4025457125034

Anthrazit · Anthracite · Anthracite







# Käsefondue Henrik / Arosa

Feuerfeste Keramik · Keramik · Creme

Ovenproof · Ceramic · Cream

Céramique incombustible · Céramique · Crème

Gilt nur für Topf  
Applies only to pot  
Valable uniquement pour le caquelon



## Käsefondue-Set Henrik 2 L

Cheese fondue-set  
Service à fondue à fromage

1 - 2

16662 4025457166624

9-teilig · 9 pieces · 9 pièces

- a Feuerfeste Keramik  
Ovenproof ceramic  
Céramique incombustible
- b Edelstahl · Stainless steel · Inox
- c Metall · Metal · Métal
- d Kunststoff · Plastic · Plastique

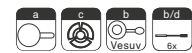

## Käsefondue-Set Arosa 0,8 L

Cheese fondue-set  
Service à fondue à fromage

1 - 6

16663 4025457166631

5-teilig · 5 pieces · 5 pièces

- a Feuerfeste Keramik  
Ovenproof ceramic  
Céramique incombustible
- b Edelstahl · Stainless steel · Inox
- c Metall · Metal · Métal
- d Kunststoff · Plastic · Plastique



Passende Textilserie Seite 114  
Matching textile series Page 114  
Série textile assortie Page 114



## Fondueschälchen Henrik

Fondue bowl · Coupelle à fondue

1 4 36

16660 4025457166600

Matt · Matt · Mat



## Fondueteller Henrik

Fondue plate · Assiette à fondue

1 6 12

16661 4025457166617

Matt · Matt · Mat

# Käsefondue Lancy & Meyrin

Aluguss · Keramische Beschichtung · Auch für Induktion geeignet  
 Cast aluminum · Ceramic non-stick coating · Also suitable for induction hobs  
 Fonte 'aluminium · Céramique revêtement antiadhésif · Compatible Induction



**Fonduegabel-Set Montana**  
 Set fondue forks  
 Set fourchettes fondue fromage

1 12 48

6-teilig · 6 pièces · 6 pièces

Griff: Antirutschoberfläche  
 Handle: Non-slip surface  
 Poignée: Surface antidérapante

**16580** 4025457165801

Taupe · Taupe · Taupe

**16581** 4025457165818

Grau · Grey · Gris



**Käsefondue-Set Lancy 2 L**  
 Cheese fondue-set  
 Service à fondue à fromage

1 - 4

10-teilig · 10 pieces · 10 pièces

**a** Aluguss · Cast aluminium · Fonte aluminium  
**a** Keramische Beschichtung  
 Ceramic non-stick coating  
 Céramique revêtement antiadhésif  
**c** Metall verchromt  
 Metal chromed · Metal chromé  
**d** Edelstahl · Stainless steel · Inox  
**e** Griff: Antirutschoberfläche  
 Handle: Non-slip surface  
 Poignée: Surface antidérapante

**16560** 4025457165603

Taupe · Taupe · Taupe



**Käsefondue-Set Lancy 2 L**  
 Cheese fondue-set  
 Service à fondue à fromage

1 - 4

10-teilig · 10 pieces · 10 pièces

**a** Aluguss · Cast aluminium · Fonte aluminium  
**a** Keramische Beschichtung  
 Ceramic non-stick coating  
 Céramique revêtement antiadhésif  
**c** Metall verchromt  
 Metal chromed · Metal chromé  
**d** Edelstahl · Stainless steel · Inox  
**e** Griff: Antirutschoberfläche  
 Handle: Non-slip surface  
 Poignée: Surface antidérapante

**16564** 4025457165641

Grau · Grey · Gris

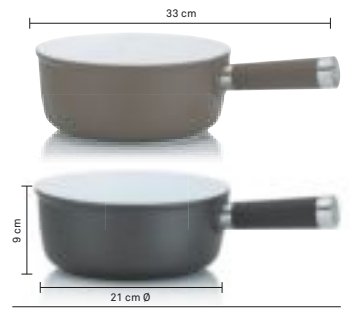

**Käsefonduepfanne Meyrin 2 L**  
 Cheese fondue pan  
 Caquelon à fondue à fromage

1 - 6

Aluguss  
 Cast aluminium · Fonte aluminium

Keramische Beschichtung  
 Ceramic non-stick coating  
 Céramique revêtement antiadhésif

Griff: Antirutschoberfläche  
 Handle: Non-slip surface  
 Poignée: Surface antidérapante

**16567** 4025457165672

Taupe · Taupe · Taupe

**16571** 4025457165719

Grau · Grey · Gris







# Käsefondue

Cheese fondues  
Fondues à fromage

Gilt nur für Topf außer 61201  
Applies only to pot  
Valable uniquement pour le caquelon



## Käsefonduepfanne Davos 2 L

Cheese fondue pan  
Caquelon à fondue à fromage

1 - 4

66573 4025457665738

Feuerfeste Keramik  
Ovenproof ceramic  
Céramique incombustible

Beige · Beige · Beige



## Käsefonduepfanne Uri 2 L

Cheese fondue pan  
Caquelon à fondue à fromage

1 - 4

66582 4025457665820

Feuerfeste Keramik  
Ovenproof ceramic  
Céramique incombustible

Rot · Red · Rouge



## Käsefondue-Set Tessin 2 L

Cheese fondue-set  
Service à fondue à fromage

1 - 2

61305 4025457613050

9-teilig · 9 pieces · 9 pièces

a Feuerfeste Keramik  
Ovenproof ceramic  
Céramique incombustible  
b Edelstahl · Stainless steel · Inox  
c Metall · Metal · Métal  
d Kunststoff · Plastic · Plastique



## Käsefondue-Set Bern 2 L

Cheese fondue-set  
Service à fondue à fromage

1 - 2

61303 4025457613036

10-teilig · 10 pieces · 10 pièces

a Feuerfeste Keramik  
Ovenproof ceramic  
Céramique incombustible  
b Edelstahl · Stainless steel · Inox  
c Metall verchromt  
Metal chromed · Métal chromé



## Fonduekarussell Natura

Fondue carousel · Carrousel à fondue

- - 1

61201 4025457612015

23-teilig · 23 pieces · 23 pièces

a Stahl emailiert · Steel enameled  
Acier émaillé  
b Edelstahl · Stainless steel · Inox  
c Metall verchromt  
Metal chromed · Métal chromé  
d Keramik · Ceramic · Céramique  
e Buche · Beech · Hêtre

Für ca. 1-1,2 L Öl oder Brühe  
For approx. 1-1,2 l oil or stock  
Pour environ 1-1,2 L d'huile ou de bouillon



## Rechaud Natura

Rechaud · Réchaud

1 - 12

61000 4025457610004

3-teilig · 3 pieces · 3 pièces

a Edelstahl · Stainless steel · Inox  
b Metall verchromt  
Metal chromed · Métal chromé  
c Buche · Beech · Hêtre



## Käsefonduepfanne Basel 2 L

Cheese fondue pan  
Caquelon à fondue à fromage

1 - 4

66575 4025457665752

Feuerfeste Keramik  
Ovenproof ceramic  
Céramique incombustible

Schwarz · Black · Noir



## Käsefondue-Set Natura 2 L

Cheese fondue-set  
Service à fondue à fromage

1 - 2

61306 4025457613067

10-teilig · 10 pieces · 10 pièces

a Feuerfeste Keramik  
Ovenproof ceramic  
Céramique incombustible  
b Edelstahl · Stainless steel · Inox  
c Metall verchromt  
Metal chromed · Métal chromé  
d Buche · Beech · Hêtre



## Natura

Buche  
Beech  
Hêtre

# Country

Serie mit Akazienholz  
Range with Acacia wood  
Gamme avec bois d'Acacia



3x Pastenbrenner mit extra langem Griff, für sicheres Entnehmen

3x Paste burner with ultra-long handle, for secure removal

3x Brûleurs à pâte avec manche extra long, pour utilisation en toute sécurité.



## Grillplatte

Grill plate · Plaque de grill

1 - 1

**16641** 4025457166419

8-teilig · 8 pieces · 8 pièces

- a Gusseisen emailliert  
Cast iron enameled  
Fonte de fer émaillée
- b Metall verchromt  
Metal chromed · Métal chromé
- c Metall schwarz · Metal black · Métal noir
- d Edelstahl · Stainless steel · Inox
- e Akazie · Acacia · Acacia



## Fondue-Set

Fondue-set · Service à fondue

1 - 1

**16644** 4025457166440

11-teilig · 11 pieces · 11 pièces

- a Gusseisen emailliert  
Cast iron enameled  
Fonte de fer émaillée
- b Metall schwarz · Metal black · Métal noir
- c Edelstahl · Stainless steel · Inox
- d Akazie · Acacia · Acacia

Für ca. 0,8-1,0 L Öl oder Brühe  
For approx. 0,8-1,0 l oil or stock  
Pour environ 0,8-1,0 L d'huile ou de bouillon



## Käsefondue-Set 2 L

Cheese fondue-set  
Service à fondue à fromage

1 - 4

**16640** 4025457166402

10-teilig · 10 pieces · 10 pièces

- a Feuerfeste Keramik · Ovenproof ceramic  
Céramique incombustible
- b Metall schwarz · Metal black · Métal noir
- c Kunststoff · Plastic · Plastique
- d Edelstahl · Stainless steel · Inox
- e Akazie · Acacia · Acacia





**Heißer Stein**

Hot stone · Pierre chaude

1 - 5

**16647** 4025457166471

2-teilig · 2 pieces · 2 pièces

Granitstein · Granite stone · Granit

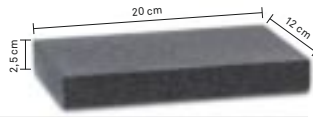

**Grillstein**

Hot stone · Pierre chaude

- 2\* 6

**16648** 4025457166488

Granitstein · Granite stone · Granit



Edelstahl  
Stainless steel · Inox

**Ofenzange für Heißen Stein**

Tong for Hot Stone

Pince pour la Pierre chaude

1 - 66

**16650** 4025457166501

Edelstahl Stainless steel · Inox  
19,5 cm x 7,5 cm



**Armata**

Akazienholz  
Acacia wood  
Bois d'Acacia



**Fonduekarussell Armata**

Fondue carrousel · Carrousel à fondue

- - 1

**66470** 4025457664700

23-teilig · 23 pieces · 23 pièces

a 18/10 Edelstahl · Stainless steel · Inox

b Edelstahl · Stainless steel · Inox

c Metall verchromt

d Keramik · Ceramic · Céramique

e Akazie · Acacia · Acacia

Für ca. 1-1,2 L Öl oder Brühe  
For approx. 1-1,2 l oil or stock  
Pour environ 1-1,2 L d'huile ou de bouillon





# Heißer Stein & Fondue



Gilt nur für Topf  
Applies only to pot  
Valable uniquement pour le caquelon



**Vulcano**  
Long Sicherheits-Pastenbrenner

**Pastenbrenner mit extra langem Griff, für sicheres Entnehmen**

Paste burner with ultra-long handle, for secure removal  
Brûleurs à pâte avec manche extra long, pour utilisation en toute sécurité

**Heißer Stein Savor**  
Hot stone · Pierre chaude

1 - 1 **16643** 4025457166433

6-teilig · 6 pieces · 6 pièces

a Granitstein · Granite stone · Granit 39 x 21 cm  
b Metall schwarz · Metal black · Métal noir  
c Edelstahl · Stainless steel · Inox



**Fondue-Set Savor**  
Fondue-set · Service à fondue

1 - 4 **16642** 4025457166426

11-teilig · 11 pieces · 11 pièces

a 18/10 Edelstahl · Stainless steel · Inox  
b Metall schwarz · Metal black · Métal noir  
c Edelstahl · Stainless steel · Inox

Für ca. 0,8-1,0 L Öl oder Brühe  
For approx. 0,8-1,0 l oil or stock  
Pour environ 0,8-1,0 L d'huile ou de bouillon



**Fonduekarussell Astana**  
Fondue carrousel · Carrousel à fondue

1 - 2 **10775** 4025457107757

23-teilig · 23 pieces · 23 pièces

a 18/10 Edelstahl · Stainless steel · Inox  
b Edelstahl · Stainless steel · Inox  
c Metall verchromt  
Metal chromed · Métal chromé  
d Keramik · Ceramics · Céramique  
e Holz · Wood · Bois

Für ca. 1-1,2 L Öl oder Brühe  
For approx. 1-1,2 l oil or stock  
Pour environ 1-1,2 L d'huile ou de bouillon



**Fondue-Set Cailin**  
Fondue-set · Service à fondue

1 - 4 **10968** 4025457109683

10-teilig · 10 pieces · 10 pièces

a 18/10 Edelstahl · Stainless steel · Inox  
b Edelstahl · Stainless steel · Inox

Für ca. 1-1,2 L Öl oder Brühe  
For approx. 1-1,2 l oil or stock  
Pour environ 1-1,2 L d'huile ou de bouillon



**Besonders niederes Fonduekarussell für perfekten Zugriff und gute Ansicht.**  
Ultra-low fondue carousel for perfect access and a good view.  
Carrousel à fondue bas.  
Simple d'utilisation.



# Fondue & Heißer Stein

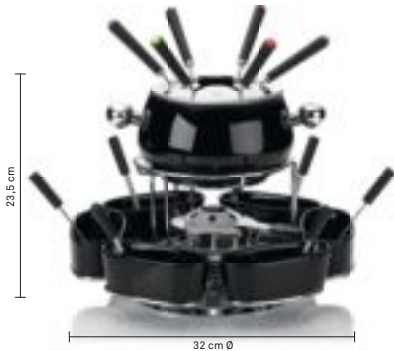

**Fonduekarussell Lugano**  
Fondue carrousel · Carrousel à fondue

1 - 1

**61203** 4025457612039

22-teilig · 22 pieces · 22 pièces

- a Emailliert · Enamelled · Emaillé
- b Edelstahl · Stainless steel · Inox
- c Metall verchromt  
Metal chromed · Métal chromé
- d Keramik · Ceramic · Céramique
- e Kunststoff · Plastic · Plastique
- f 18/10 Edelstahl · Stainless steel · Inox

Für ca. 0,8 - 1,0 L Öl oder Brühe  
For about 0,8 - 1,0 L oil or broth  
Pour 0,8 - 1,0 L d'huile ou de bouillon

Schwarz · Black · Noir



**Fondue-Set Siena**  
Fondue-set · Service à fondue

1 - 6

**16635** 4025457166358

11-teilig · 11 pieces · 11 pièces

- a Emailliert · Enamelled · Emaillé
- b Edelstahl · Stainless steel · Inox
- c Metall verchromt  
Metal chromed · Métal chromé
- d Kunststoff · Plastic · Plastique
- e 18/10 Edelstahl · Stainless steel · Inox

Für ca. 0,8 - 1,0 L Öl oder Brühe  
For about 0,8 - 1,0 L oil or broth  
Pour 0,8 - 1,0 L d'huile ou de bouillon

Weiß · White · Blanc

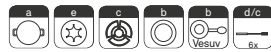

**Fondue-Set Siena**  
Fondue-set · Service à fondue

1 - 6

**66386** 4025457663864

11-teilig · 11 pieces · 11 pièces

- a Emailliert · Enamelled · Emaillé
- b Edelstahl · Stainless steel · Inox
- c Metall verchromt  
Metal chromed · Métal chromé
- d Kunststoff · Plastic · Plastique
- e 18/10 Edelstahl · Stainless steel · Inox

Für ca. 0,8 - 1,0 L Öl oder Brühe  
For about 0,8 - 1,0 L oil or broth  
Pour 0,8 - 1,0 L d'huile ou de bouillon

Schwarz · Black · Noir

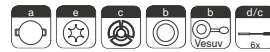

Gilt nur für Topf

Applies only to pot

Valable uniquement pour le caquelon



**Fondue-Set Comore**  
Fondue-set · Service à fondue

1 - 4

**16639** 4025457166396

11-teilig · 11 pieces · 11 pièces

- a Gusseisen emailliert  
Cast iron enamelled · Fonte de fer émaillé
- b Edelstahl · Stainless steel · Inox
- c Metall verchromt  
Metal chromed · Métal chromé

Für ca. 0,6 - 0,8 L Öl oder Brühe  
For about 0,6 - 0,8 L oil or broth  
Pour 0,6 - 0,8 L d'huile ou de bouillon

Schwarz · Black · Noir



**Heißer Stein Gourmet**  
Hot stone · Pierre Chaude

1 - 2

**66510** 4025457665103

6-teilig · 6 pieces · 6 pièces

- a Granitstein · Granite stone · Granit
- b Edelstahl · Stainless steel · Inox
- c Metall verchromt  
Metal chromed · Métal chromé

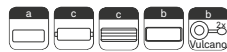

**Vulcano**  
Long Sicherheits-Pastenbrenner

**Pastenbrenner mit extra langem Griff, für sicheres Entnehmen**  
Paste burner with ultra-long handle, for secure removal  
Brûleurs à pâte avec manche extra long, pour utilisation en toute sécurité

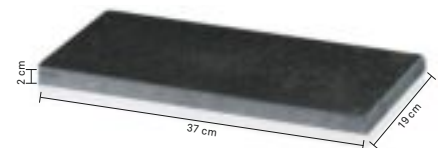

**Grillstein Gourmet**  
Hot stone · Pierre Chaude

1 - 3

**66513** 4025457665134

Granitstein · Granite · Granit

Passend zu · Suitable for · Adaptable pour 66510

# Schokofondue

Keramik

Chocolate fondue Ceramic

Set fondue à chocolat Céramique

**Ohne Teelicht**  
Without tealight / Sans bougie chauffe-plat



**Schokofondue-Set Ledora 300 ml**  
Chocolate fondue set  
Set fondue à chocolat

1 - 24

**12422** 4025457124228

4-teilig · 4 pieces · 4 pièces

a Keramik · Ceramic · Céramique  
b Edelstahl · Stainless steel · Inox  
c Kunststoff · Plastic · Plastique

Türkis/Braun  
Turquoise/Brown · Turquoise/Brun



**Schokofondue-Set Leonia 400 ml**  
Chocolate fondue set  
Set fondue à chocolat

1 - 12

**12421** 4025457124211

4-teilig · 4 pieces · 4 pièces

a Keramik · Ceramic · Céramique  
b Edelstahl · Stainless steel · Inox  
c Holz · Wood · Bois

Opalgrau/Creme  
Opal grey/cream · Gris opal/Crème



**Schokofondue-Set Fiore 250 ml**  
Chocolate fondue set  
Set fondue à chocolat

1 - 6

**12423** 4025457124235

7-teilig · 7 pieces · 7 pièces

a Keramik · Ceramic · Céramique  
b Edelstahl · Stainless steel · Inox  
c Kunststoff · Plastic · Plastique

Braun/Hellbraun  
Brown/Light brown · Brun/Brun clair



**Schokofondue-Set Amuri 300 ml**  
Chocolate fondue set  
Set fondue à chocolat

1 - 12

**12420** 4025457124204

4-teilig · 4 pieces · 4 pièces

a Keramik · Ceramic · Céramique  
b Edelstahl · Stainless steel · Inox  
c Kunststoff · Plastic · Plastique

Rot/Creme  
Red/Cream · Rouge/Crème



**Schokofondue-Set Alva 300 ml**  
Chocolate fondue set  
Set fondue à chocolat

1 - 12

**12425** 4025457124259

4-teilig · 4 pieces · 4 pièces

a Keramik · Ceramic · Céramique  
b Edelstahl · Stainless steel · Inox  
c Kunststoff · Plastic · Plastique

Weiß · White · Blanc



**Schokofondue-Set Alicia 200 ml**  
Chocolate fondue set  
Set fondue à chocolat

1 - 8

**12426** 4025457124266

4-teilig · 4 pieces · 4 pièces

a Keramik · Ceramic · Céramique  
b Edelstahl · Stainless steel · Inox  
c Kunststoff · Plastic · Plastique

Weiß · White · Blanc



# Schälchen & Fondueteller

Keramik  
Ceramic  
Céramique



**Fondueschälchen Chalet**  
Fondue bowl · Coupelle à fondue

1	4	36
<b>67451</b>	4025457674518	
Weiß · White · Blanc		
Glänzend · Bright · Brillant		



**Fondueschälchen Chalet**  
Fondue bowl · Coupelle à fondue

1	4	36
<b>67450</b>	4025457674501	
Schwarz · Black · Noir		
Glänzend · Bright · Brillant		



**Fondueteller Arcade**  
Fondue plate · Assiette à fondue

1	6	12
<b>67837</b>	4025457678370	
Weiß · White · Blanc		
Glänzend · Bright · Brillant		



**Fondueteller Anneli**  
Fondue plate · Assiette à fondue

1	6	12
<b>67403</b>	4025457674037	
Weiß · White · Blanc		
Glänzend · Bright · Brillant		



**Fondueteller Vroni**  
Fondue plate · Assiette à fondue

1	6	12
<b>67406</b>	4025457674068	
Weiß · White · Blanc		
Glänzend · Bright · Brillant		



**Fondueteller Arcade**  
Fondue plate · Assiette à fondue

1	6	12
<b>67838</b>	4025457678387	
Schwarz · Black · Noir		
Matt · Mat · Mat		



**Fondueteller Anneli**  
Fondue plate · Assiette à fondue

1	6	12
<b>67404</b>	4025457674044	
Schwarz · Black · Noir		
Glänzend · Bright · Brillant		



**Fondueteller Vroni**  
Fondue plate · Assiette à fondue

1	6	12
<b>67405</b>	4025457674051	
Schwarz · Black · Noir		
Glänzend · Bright · Brillant		

# Fleischfonduegabeln & Fonduelöffel

Fondue fork & Fondue spoons  
Fourchette à fondue & Cuillères à fondue

Edelstahl  
Stainless steel · Inox

Fleischfonduegabeln  
Fondue fork  
Fourchette à fondue

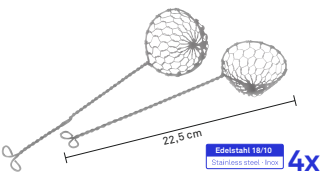

**Siebe-Set Tamis**  
Strainer set · Set passeroies mini  
1 - 60  
**77924** 402545779244

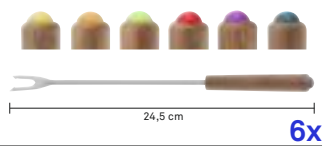

**Modessa**  
1 12 48  
**79164** 4025457791642  
Griff · Handle · Poignée  
Akazie · Acacia · Acacia

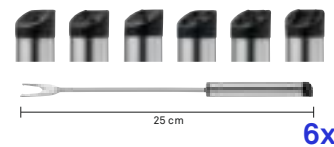

**Belana**  
1 12 48  
**79184** 4025457791840  
Griff · Handle · Poignée  
Edelstahl · Stainless steel · Inox

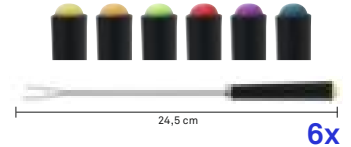

**Morena**  
1 12 48  
**79313** 4025457793134  
Griff · Handle · Poignée  
Kunststoff · Plastic · Plastique

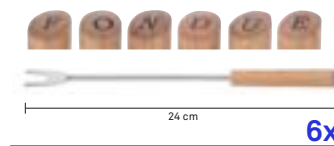

**Bergamo**  
1 12 48  
**79168** 4025457791680  
Griff · Handle · Poignée  
Buche · Beech · Hêtre

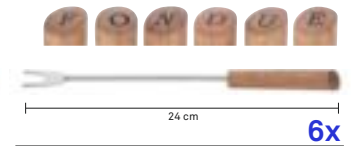

**Messina**  
1 12 48  
**79169** 4025457791697  
Griff · Handle · Poignée  
Akazie · Acacia · Acacia

Fonduelöffel  
Fondue spoons  
Cuillères à fondue

Edelstahl  
Stainless steel · Inox

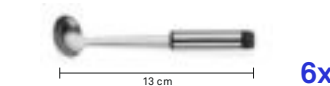

**Belana**  
1 12 48  
**79185** 4025457791857  
Griff · Handle · Poignée  
Edelstahl · Stainless steel · Inox



**Morena**  
1 12 48  
**79312** 4025457793127  
Griff · Handle · Poignée  
Kunststoff · Plastic · Plastique



**Modessa**  
1 12 48  
**79170** 4025457791703  
Griff · Handle · Poignée  
Akazie · Acacia · Acacia



**Bergamo**  
1 12 48  
**79171** 4025457791710  
Griff · Handle · Poignée  
Buche · Beech · Hêtre



# Käsefonduegabeln & Schokofonduegabeln

Cheese fondue fork & Chocolate fondue fork  
Fourchette à fondue au fromage en Fourchette à fondue au chocolat

Edelstahl  
Stainless steel · Inox

Käsefonduegabeln  
Cheese fondue fork  
Fourchette à fondue au fromage

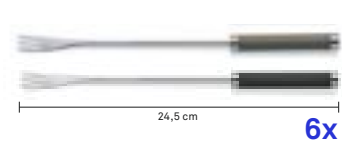

**Montana**

1 12 48

Griff: Antirutschoberfläche  
Handle: Non-slip surface  
Poignée: Surface antidérapante

**16580** 4025457165801

Taupe · Taupe · Taupe

**16581** 4025457165818

Grau · Grey · Gris

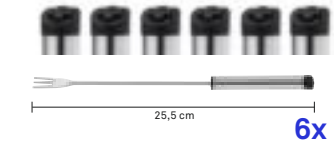

**Belana**

1 12 48

**79186** 4025457791864

Griff · Handle · Poignée  
Edelstahl · Stainless steel · Inox

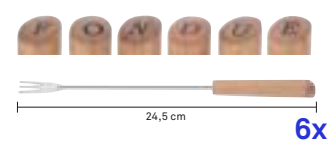

**Bergamo**

1 12 48

**79167** 4025457791673

Griff · Handle · Poignée  
Buche · Beech · Hêtre

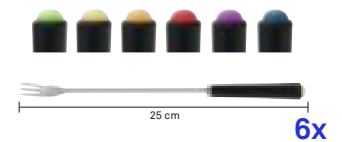

**Morena**

1 12 48

**79314** 4025457793141

Griff · Handle · Poignée  
Kunststoff · Plastic · Plastique



Schokofonduegabel  
Chocolate fondue fork  
Fourchette à fondue au chocolat

Edelstahl  
Stainless steel · Inox

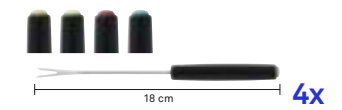

**Sweet**

1 12 72

**79194** 4025457791949

Griff · Handle · Poignée  
Kunststoff · Plastic · Plastique



# Zubehör

Accessories  
Accessoires



Edelstahl  
Stainless steel · Inox

10 cm Ø

GEFAHR  
DANGER

**Pastenbrenner-Set Vesuv**  
Set of paste burner · Set brûleur à pâte

1 - 25

**63067** 4025457630675

Edelstahl · Stainless steel · Inox

Brennpaste  
Combustible paste · Pâte à brûler

UN 1170



Vulcano  
Long Sicherheits-Pastenbrenner

Edelstahl  
Stainless steel · Inox

10,5 cm

GEFAHR  
DANGER

**Pastenbrenner-Set Vulcano**  
Set of paste burner · Set brûleur à pâte

1 - 24

**63085** 4025457630859

Edelstahl · Stainless steel · Inox

Brennpaste  
Combustible paste · Pâte à brûler

UN 1170



3x

Edelstahl  
Stainless steel · Inox

GEFAHR  
DANGER

**Brennpasten-Set Magma**  
Set of combustible paste  
Set pâte à brûler

1 - 24

**63018** 4025457630187

3 x 80 g

UN 1170



Edelstahl  
Stainless steel · Inox

GEFAHR  
DANGER

**Brennpastenflasche Liquid 1,0 L**  
Bottle with combustible paste  
Bouteille combustible liquide

- - 12\*

**63054** 4025457630545

1,0 L / 800 g

UN 1170



15,5 cm Ø

**Flammenverteiler Balerno**  
Heat regulating plate  
Répartiteur de chaleur

1 5 250

**66595** 4025457665950

Aluminium · Aluminium · Aluminium



10,5 cm

23,5 cm Ø

Edelstahl  
Stainless steel · Inox

**Rechaud Maxi**  
Rechaud · Réchaud

1 - 12

**60127** 4025457601279

3-teilig · 3 pieces · 3 pièces

a Edelstahl · Stainless steel · Inox  
b Metall verchromt  
Metal chromed · Métal chromé



14,5 cm

26 cm Ø

Edelstahl  
Stainless steel · Inox

**Rechaud Hot**  
Rechaud · Réchaud

1 - 4

**60170** 4025457601705

3-teilig · 3 pieces · 3 pièces

a Edelstahl · Stainless steel · Inox  
b Metall verchromt  
Metal chromed · Métal chromé



8,5 cm

7,5 cm Ø

Edelstahl  
Stainless steel · Inox

**Gasbrenner Hot**  
Gas burner · Brûleur gaz

1 6 24

**63040** 4025457630408

Edelstahl · Stainless steel · Inox

Nachfüllbar · Refillable · Rechargeable



Verteilt die Hitze gleichmäßig auf dem Boden der Käsefonduepfanne und verhindert somit das Anbrennen.

Distributes the heat evenly, to prevent cheese burning on.  
Réparti la chaleur sous le caquelon de fondue à fromage pour une cuisson uniforme.

Gasbrenner besonders geeignet für Woks  
Gas burner especially for woks  
Brûleur gaz idéal pour wok



# Feuerzangenbowle

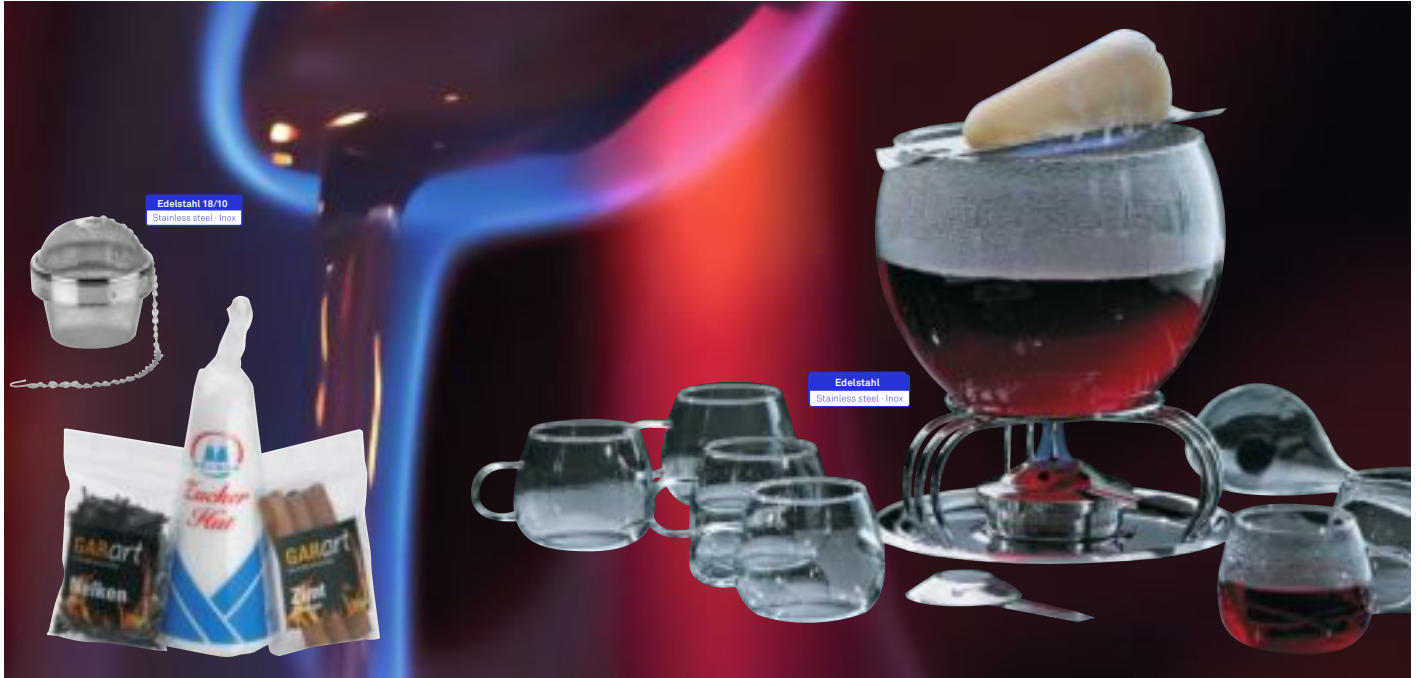

## Feuerzangenbowle

Heinz Rühmann 3,5 L  
Punch set · Set à punch

1 - 1

66000 4025457660009

16-teilig · 16 pieces · 16 pièces

- a Hitzebeständiges Glas  
Heat-resistant glass  
Verre résistant à chaleur
- b Edelstahl · Stainless steel · Inox
- c Metall verchromt  
Metal chromed · Métal chromé
- d SAN-Kunststoff  
SAN plastic · SAN-Plastique
- e 18/10 Edelstahl · Stainless steel · Inox

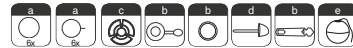

## Minizuckerzangen-Set Picco

Set of sugar tongs · Set de pince à sucre

1 - 48

11664 4025457116643

2-teilig · 2 pieces · 2 pièces

18/10 Edelstahl · Stainless steel · Inox



## Zubehör

Accessories  
Accessoires



### Bowlöffel Patrice

Punch bowl ladle · Cuillère à punch

1 - 250

65149 4025457651496

SAN-Kunststoff · SAN plastic · SAN-Plastique



### Bowleglas Fina 250 ml

Set of punch glasses · Set verres à punch

1 - 6

66163 4025457661631

Glas · Glass · Verre

Hitzebeständig  
Heat-resistant · Résistant à la chaleur



### Bowltopf Fina 3,5 L

Punch bowl · Pot à punch

1 - 1

66164 4025457661648

Glas · Glass · Verre

Hitzebeständig  
Heat-resistant · Résistant à la chaleur



### Zuckerzange Tura

Sugar tongs · Pince à sucre

1 - 60

65147 4025457651472

Edelstahl · Stainless steel · Inox







# *Ordnung gibt es auch in Wunderschön*

Tidy can also be beautiful

Conserver avec élégance

# Vorratsdosen

Storage jar  
Bocal hermétique



## Amelie

Borosilikat-Glas · Deckel aus Buche  
Borosilicate glass · Beechwood lid  
Verre borosilicate · Couvercle en hêtre

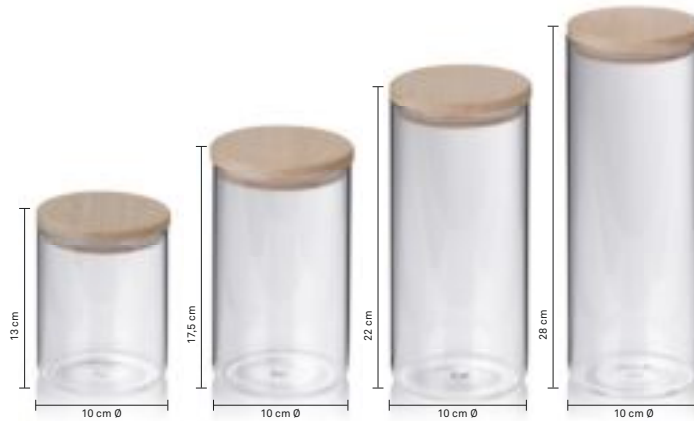

Vorratsdose			
Storage jar · Bocal hermétique			
-	4*	12	0,8 L
<b>11955</b>	4025457119552		
-	4*	12	1,0 L
<b>11956</b>	4025457119569		
-	4*	12	1,5 L
<b>11957</b>	4025457119576		
-	4*	12	1,9 L
<b>11958</b>	4025457119583		



## Baker

Borosilikat-Glas · Deckel aus Edelstahl 18/10  
Borosilicate glass · Stainless steel 18/10 lid  
Verre borosilicate · Couvercle en inox 18/10

Edelstahl 18/10  
Stainless steel · Inox



Vorratsdose			
Storage jar · Bocal hermétique			
-	6*	24	0,25 L
<b>10765</b>	4025457107658		
-	6*	24	0,35 L
<b>10766</b>	4025457107665		

Vorratsdose			
Storage jar · Bocal hermétique			
-	4*	24	0,6 L
<b>10767</b>	4025457107672		
-	4*	16	1,1 L
<b>10768</b>	4025457107689		
-	4*	16	1,3 L
<b>10769</b>	4025457107696		



# Vorratsdosen Arik

Borosilikat-Glas · Deckel aus ABS/PP-Kunststoff  
 Borosilicate glass · Lid: ABS/PP plastic  
 Verre de borosilicate · Couvercle: ABS/PP-plastique



Mit Silikonring  
 With silicone ring  
 Avec anneau en silicone



Luft- und aromadicht  
 Air-tight, keeps the flavour in  
 Parfaitement hermétique



Vorratsdose				
Storage jar · Bocal hermétique				
-	4*	12		0,6 L
<b>12104</b>	4025457121043			
-	4*	12		0,9 L
<b>12105</b>	4025457121050			
-	4*	12		1,2 L
<b>12106</b>	4025457121067			

Weiß · White · Blanc



Vorratsdose				
Storage jar · Bocal hermétique				
-	4*	12		0,6 L
<b>12107</b>	4025457121074			
-	4*	12		0,9 L
<b>12108</b>	4025457121081			
-	4*	12		1,2 L
<b>12109</b>	4025457121098			

Grau · Grey · Gris

# Vorratsdosen

Glas  
Glass  
Verre



## Wilma

Deckel aus Bambus  
Bamboo lid  
Couvercle en Bambou

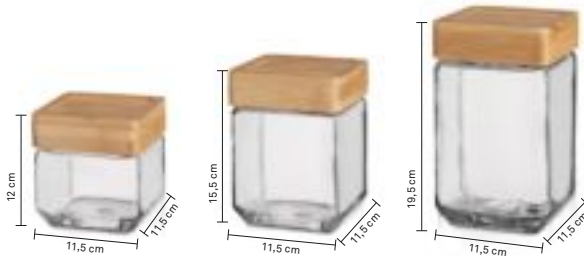

Vorratsdose			
Storage jar · Bocal hermétique			
-	4*	12	0,75 L
<b>11925</b>	4025457119255		
-	4*	12	1,0 L
<b>11926</b>	4025457119262		
-	4*	8	1,6 L
<b>11927</b>	4025457119279		



## Bera

Deckel Edelstahl 18/10  
Stainless steel 18/10 lid  
Couvercle en inox 18/10

Edelstahl 18/10  
Stainless steel · Inox



Vorratsdose			
Storage jar · Bocal hermétique			
-	4*	12	0,8 L
<b>17870</b>	4025457178702		
-	4*	12	1,2 L
<b>17869</b>	4025457178696		
-	4*	12	1,7 L
<b>17868</b>	4025457178689		
-	4*	12	2,1 L
<b>17867</b>	4025457178672		



## Rosa & Thea



11920

11921

**4x**

Vorratsdosen-Set Rosa 0,2 L			
Storage jars set			
Set bocal hermétique			
1	-	12	📦
<b>11920</b>	4025457119200		
Deckel aus Kunststoff Lid: Plastic · Couvercle: Plastique			

**3x**

Vorratsdosen-Set Thea 0,25 L			
Storage jars set			
Set bocal hermétique			
1	-	16	📦
<b>11921</b>	4025457119217		



# Vorratsdosen

## Mellis

Keramik · Deckel aus Gummibaumholz  
 Ceramic · Rubberwood lid  
 Céramique · Couvercle en hévéa



### Vorratsdose

Storage jar · Bocal hermétique		
- 4*	12	0,8 L
<b>12084</b>	4025457120848	
- 4*	12	1,3 L
<b>12085</b>	4025457120855	
Creme · Cream · Crème		

### Opalgrau · Opal grey · Gris Opal

- 4*	12	0,8 L
<b>12086</b>	4025457120862	
- 4*	12	1,3 L
<b>12087</b>	4025457120879	

### Pastellblau · Pastel blue · Bleu Pastel

- 4*	12	0,8 L
<b>12088</b>	4025457120886	
- 4*	12	1,3 L
<b>12089</b>	4025457120893	

## Jule

Aus hochwertigem und robustem MS-Kunststoff · Stapelbar · Luftdicht  
 High quality and sturdy MS plastic · Stackable · Airtight close  
 En MS-résine de haute qualité et robuste · Empilable · Hermétiquement scellé

Optimales Aufbewahren,  
 dank stapelbarem Deckelsystem

Optimum storage, thanks  
 to stacking lid system

Rangement facilité par  
 système d'empilage



### Vorratsdose

Storage jar · Bocal hermétique		
- 4*	48	0,5 L
<b>12050</b>	4025457120503	
- 4*	32	0,8 L
<b>12051</b>	4025457120510	
- 4*	24	1,2 L
<b>12052</b>	4025457120527	
- 4*	16	1,9 L
<b>12053</b>	4025457120534	
Quadratisch · Square · Carré		



# Brotkasten

Für längere Frische  
Keeps bread fresh and crispy  
Frais et Croustillant

## Namur

PS-Kunststoff · Deckel aus Bambus  
PS plastic · Bamboo lid  
PS-plastique · Couvercle en Bambou



Luftlöcher im Schriftzug auf dem Deckel des Brotkastens sorgen für längere Frische.

Air holes in the lettering on the lid of the bread bin keep bread fresh.  
De minuscules trous d'aération afin d'éviter les moisissures et de conserver la fraîcheur.



### Brotkasten

Bread bin · Boîte à pain

- - 2\*

12060 4025457120602

Weiß · White · Blanc



### Beige · Beige · Beige

- - 2\*

12061 4025457120619



### Opalgrau · Opal grey · Gris opal

- - 2\*

12062 4025457120626



### Dunkelgrau · Dark grey · Gris fonce

- - 2\*

12063 4025457120633

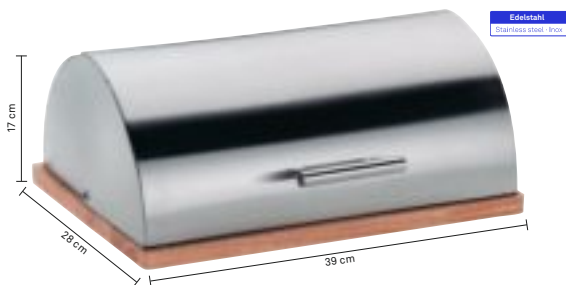

### Brotkasten De Luxe

Bread bin · Boîte à pain

1 - 2

19210 4025457192104

Edelstahl · Stainless steel · Inox

Matt · Matt · Mat

Holzplatte · Wooden base · Socle en bois

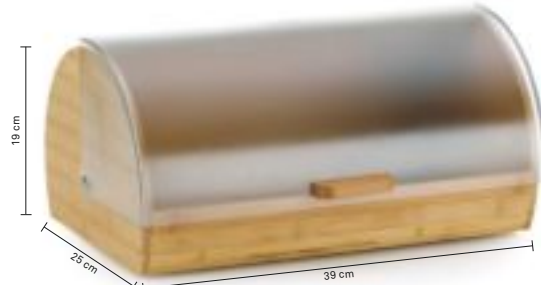

### Brotkasten Katana

Bread bin · Boîte à pain

1 - 4

11841 4025457118418

Bambus · Bamboo · Bambou

PS-Kunststoff · PS plastic · PS-plastique



# Brotkasten Friscolino & Frisco

Metall glänzend mit farbiger Beschichtung

Metal bright with coloured coating

Métal brillant avec revêtement coloré



Luftlöcher an der Rückseite des Brotkastens sorgen für längere Frische. Gummknöpfe sorgen für ein leises Schließen.

Rubber studs for soft closure, ventilation for lasting freshness and to combat mould.

Bouton gomme pour une fermeture silencieuse, une meilleure aération afin d'éviter les moisissures.



<b>Brotkasten Friscolino</b>	
Bread bin · Boîte à pain	
1	- 4
<b>11176</b>	4025457111761
Weiß · White · Blanc	



<b>Brotkasten Friscolino</b>	
Bread bin · Boîte à pain	
1	- 4
<b>11177</b>	4025457111778
Hellgrau · Light grey · Gris clair	



<b>Brotkasten Frisco</b>	
Bread bin · Boîte à pain	
1	- 4
<b>11190</b>	4025457111907
Opalgrau · Opal grey · Gris opal	



<b>Weiß · White · Blanc</b>	
1	- 4
<b>11165</b>	4025457111655



<b>Beige · Beige · Beige</b>	
1	- 4
<b>11168</b>	4025457111686



<b>Hellgrau · Light grey · Gris clair</b>	
1	- 4
<b>11167</b>	4025457111679



<b>Pastelltürkis</b>	
Pastel turquoise · Turquoise pastel	
1	- 4
<b>11191</b>	4025457111914

# Salena

Keramik mit Deckel aus Bambus

Ceramic with bamboo lid

Céramique avec couvercle en bambou



Luftlöcher sorgen für längere Frische

Ventilation for lasting freshness

Une meilleure aération afin d'éviter les moisissures



**Brotkasten**  
Bread bin · Boîte à pain

1 - 2

12064 4025457120640



**Knoblauchtopf**  
Garlic pot · Pot d'ail

1 - 6

12066 4025457120664



**Zwiebeltopf**  
Onion pot · Pot d'oignon

1 - 4

12067 4025457120671



# Küchenrollenhalter



**Küchenrollenhalter Caro**  
Kitchen roll holder · Support à essuie-tout

1	12	24	📦
<b>12238</b>	4025457122385		



**Küchenrollenhalter Globul**  
Kitchen roll holder · Support à essuie-tout

1	12	24	📦
<b>17582</b>	4025457175824		

## Caro & Globul

Metall verchromt  
Metal chromed  
Métal chromé



**Edelstahl** · Stainless steel · Inox

1	-	12	📦
<b>16920</b>	4025457169205		

Matt · Matt · Mat



**Opalgrau** · Opal grey · Gris opal

1	-	12	📦
<b>16919</b>	4025457169199		



**Pastellblau** · Pastel blue · Bleu pastel

1	-	12	📦
<b>16918</b>	4025457169182		

## Rollo

Metall farbig beschichtet  
Colour-coated metal  
Métal revêtement couleur

**Edelstahl**  
Stainless steel · Inox



**Opalgrau** · Opal grey · Gris opal

1	-	12	📦
<b>11198</b>	4025457111983		



**Weiß** · White · Blanc

1	-	12	📦
<b>11201</b>	4025457112010		



**Hellgrau** · Light grey · Gris clair

1	-	12	📦
<b>11203</b>	4025457112034		



**Schwarz** · Black · Noir

1	-	12	📦
<b>11200</b>	4025457112003		

## Stella

Metall farbig beschichtet  
Colour-coated metal  
Métal revêtement couleur

**Edelstahl**  
Stainless steel · Inox

# Aufbewahrungskorb Mika

PP-Kunststoff  
PP plastic  
PP-plastique

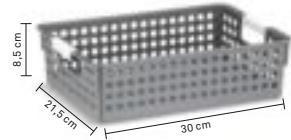

<b>Korb</b>
Basket · Corbeille
Grau · Grey · Gris
Griff: Weiß Handle: White Poignée: Blanc

<b>Korb</b>
Basket · Corbeille
1 12 36
<b>12350</b> 4025457123504

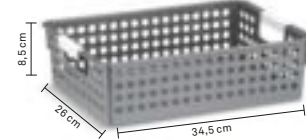

<b>Korb</b>
Basket · Corbeille
1 12 36
<b>12351</b> 4025457123511

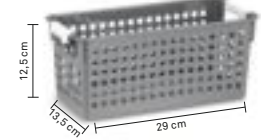

<b>Korb</b>
Basket · Corbeille
1 9 36
<b>12352</b> 4025457123528

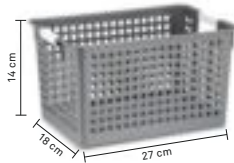

<b>Korb</b>
Basket · Corbeille
1 12 36
<b>12353</b> 4025457123535

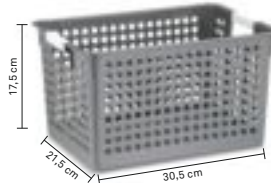

<b>Korb</b>
Basket · Corbeille
1 12 24
<b>12354</b> 4025457123542

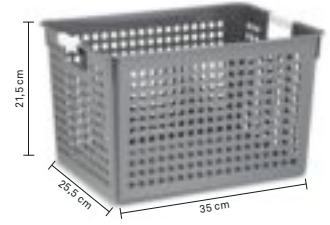

<b>Korb</b>
Basket · Corbeille
1 12 24
<b>12355</b> 4025457123559

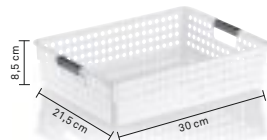

<b>Korb</b>
Basket · Corbeille
Weiß · White · Blanc
Griff: Silbergrau Handle: Silver grey Poignée: Gris argent

<b>Korb</b>
Basket · Corbeille
1 12 36
<b>11965</b> 4025457119651



<b>Korb</b>
Basket · Corbeille
1 12 36
<b>11966</b> 4025457119668



<b>Korb</b>
Basket · Corbeille
1 9 36
<b>11967</b> 4025457119675



<b>Korb</b>
Basket · Corbeille
1 12 36
<b>11968</b> 4025457119682

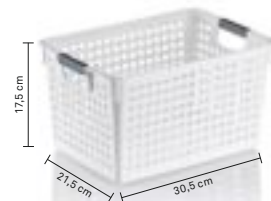

<b>Korb</b>
Basket · Corbeille
1 12 24
<b>11969</b> 4025457119699



<b>Korb</b>
Basket · Corbeille
1 12 24
<b>11970</b> 4025457119705

# Antirutschmatte

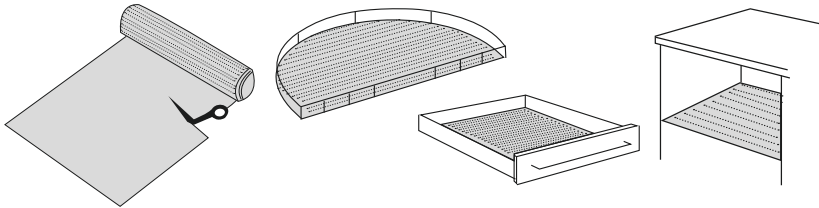

## 36 Stück im Verkaufsdisplay

36 pieces  
in the customer attractive display.  
A partir de 36 pièces  
dans un présentoir motivant.

L31 / T31 / H51

**Gute Antirutsch-Eigenschaft**  
**Einfaches Zuschneiden**  
**Geräuschdämmend**  
**Leicht zu reinigen**  
**feucht abwischbar**

Good non-slip properties  
Ease of cutting  
Sound-insulating  
Easy to clean – wipe when damp

Bonne propriété anti dérapante  
Découpage facile  
Atténue les bruits  
Nettoyage facile



## 25 Stück im Verkaufsdisplay

25 pieces in the customer  
attractive display.  
A partir de 25 pièces  
dans un présentoir motivant.

L30,5 / T19 / H26,5

**Extrem rutschhemmend**  
**Dünn und sehr anschmiegsam**  
**Passt perfekt in Ecken und Kanten**  
**Einfaches Zuschneiden**  
**Geräuschdämmend**  
**Leicht zu reinigen**  
**Feucht abwischbar**

Extremely slip-resistant  
Thin and extremely soft and smooth  
Fits corners and edges perfectly  
Simple to cut  
Noise-insulating  
Easy-clean - wipeable

Extrêmement antidérapant  
Fin et extrêmement souple  
S'adapte parfaitement aux bords et  
aux recoins  
Facile à découper  
Insonorisant  
Facile à nettoyer - essuyable



### Schubladenmatte Soletta

Drawer mat · Tapis de tiroir

- - 36\* 

11390 4025457113901

EVA-Kunststoff  
EVA plastic · EVA-plastique

Transparent · Transparent · Transparent

150 x 50 cm



### Antirutschmatte Linnea

Non-slip mat · Tapis antidérapant

- - 25\* 

11389 4025457113895

PVC · PVC · PVC

Grau · Grey · Gris

150 x 50 cm



# Schubladeneinteilungen



## Kalma

Bambus  
Bamboo  
Bambou



**Besteckkasten**  
Cutlery box · Range couverts

1 - 8

12011 4025457120114



**Besteckkasten**  
Cutlery box · Range couverts

1 - 8

12012 4025457120121

Ausziehbar · Expendable · Extensible



**Besteckkasten**  
Cutlery box · Range couverts

1 - 6

12013 4025457120138

Ausziehbar · Expendable · Extensible



## Gaveta

PP-Kunststoff weiß gefrostet  
PP-plastic white frosted  
PP-plastique blanc givré



**Schubladeneinteiler**  
Drawer organiser · Organisateur de tiroir

- 6\* 48

11380 4025457113802



**Schubladeneinteiler**  
Drawer organiser · Organisateur de tiroir

- 6\* 48

11381 4025457113819

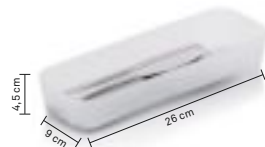

**Schubladeneinteiler**  
Drawer organiser · Organisateur de tiroir

- 6\* 48

11382 4025457113826



**Schubladeneinteiler**  
Drawer organiser · Organisateur de tiroir

- 6\* 24

11383 4025457113833



**Schubladeneinteiler**  
Drawer organiser · Organisateur de tiroir

- 6\* 24

11384 4025457113840



Mit Anti-rutsch Einlage  
With non-slip mat  
Avec tapis anti-dérapage

## Laila & Lania

PETG Kunststoff / PP-Kunststoff  
PETG plastic / PP plastic  
PETG-plastique / PP-plastique

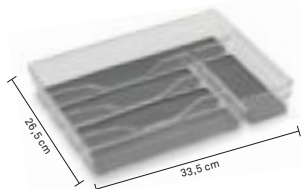

**Besteckkasten Laila**  
Cutlery box · Range couverts

1 - 12

11537 4025457115370

Einlage: Rutschfest, herausnehmbar, grau  
Insert: Non-slip, removable, grey  
Insert: Antidérapant, amovible, gris

Transparent · Transparent · Transparent



**Besteckkasten Lania**  
Cutlery box · Range couverts

1 - 6

11519 4025457115196

Einlage: Rutschfest, grau  
Insert: Non-slip, grey  
Insert: Antidérapant, gris

Weiß · White · Blanc



**Besteckkasten Lania**  
Cutlery box · Range couverts

1 - 6

11520 4025457115202

Einlage: Rutschfest, grau  
Insert: Non-slip, grey  
Insert: Antidérapant, gris

Weiß · White · Blanc



# Spülzubehör



**Spülstation Purana 350 ml**  
Dishwashing center  
Distributeur à savon multi usages

---

1 - 12

---

**12080** 4025457120800

---

Keramik mit soft touch  
Ceramic with soft touch  
Céramique avec soft touch

---

Fach passend für Glänzerkissen 11647  
Suitable for Sparkle sponge 11647  
Conçu pour l'éponge métallique 11647

---

Weiß · White · Blanc



**Spülstation Purana 350 ml**  
Dishwashing center  
Distributeur à savon multi usages

---

1 - 12

---

**12081** 4025457120817

---

Keramik mit soft touch  
Ceramic with soft touch  
Céramique avec soft touch

---

Fach passend für Glänzerkissen 11647  
Suitable for Sparkle sponge 11647  
Conçu pour l'éponge métallique 11647

---

Hellgrau · Light grey · Gris clair

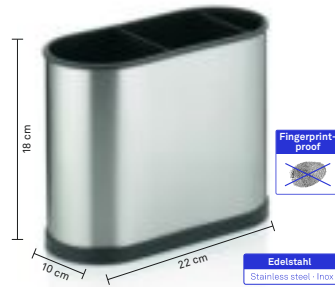

**Besteckabtropfer Benito**  
Cutlery holder · Egouttoir à couvert

---

1 - 12

---

**11668** 4025457116681

---

Edelstahl · Stainless steel · Inox

---

PP-Kunststoff · PP plastic · PP-plastique

---

Matt · Matt · Mat



**Besteckabtropfer Benito**  
Cutlery holder · Egouttoir à couvert

---

1 - 12

---

**11659** 4025457116599

---

Metall farbig beschichtet  
Colour-coated metal  
Métal revêtement couleur

---

PP-Kunststoff · PP plastic · PP-plastique

---

Weiß · White · Blanc



**Edelstahl**  
Stainless steel · Inox

**Hohe Reinigungswirkung - Ideal für Edelstahlkochgeschirr**  
Excellent cleaning effect - Ideal for stainless steel cookware  
Grande propriété nettoyante - Idéal pour ustensiles de cuisson



**Kratzt nicht - Ideal für beschichtete Pfannen & Ceranfelder**  
Non-scratch - Ideal for coated pans & ceramic hobs  
Ne raye pas - Idéal pour poêles à revêtement & plaques vitro-céramiques



**Edelstahl 18/10**  
Stainless steel · Inox

**Für Glaskeramikfelder oder andere glatte Oberflächen**  
For glass ceramic panels or other smooth surfaces  
Pour panneaux en vitrocéramique ou autres surfaces lisses



**Reinigungsbälle Pano 15 g**  
Cleaning balls  
Eponges inox

---

- 12\* 72

---

**11648** 4025457116483

---

Edelstahl · Stainless steel · Inox



**Glänzerkissen Pulito**  
Sparkle sponges  
Eponges métalliques

---

- 6\* 24

---

**11647** 4025457116476

---

Polyester · Polyester · Polyester

---

Silber · Silver · Argent



**Kochfeldreiniger Vision**  
Ceran hob cleaner  
Grattoir à plaques vitro céramique

---

1 12 144

---

**19248** 4025457192487



**Ersatzklingen-Set Vision**  
Replacement blades  
Lames de remplacement

---

1 10 100

---

**22001** 4002632921636

---

Metall · Metal · Métal

# Spülzubehör

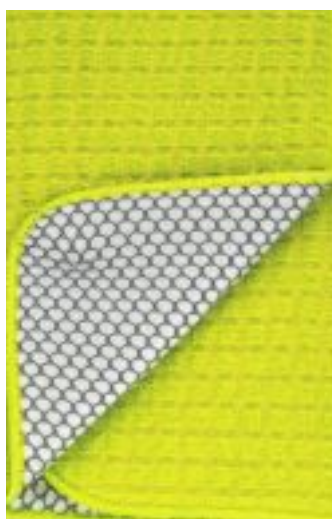
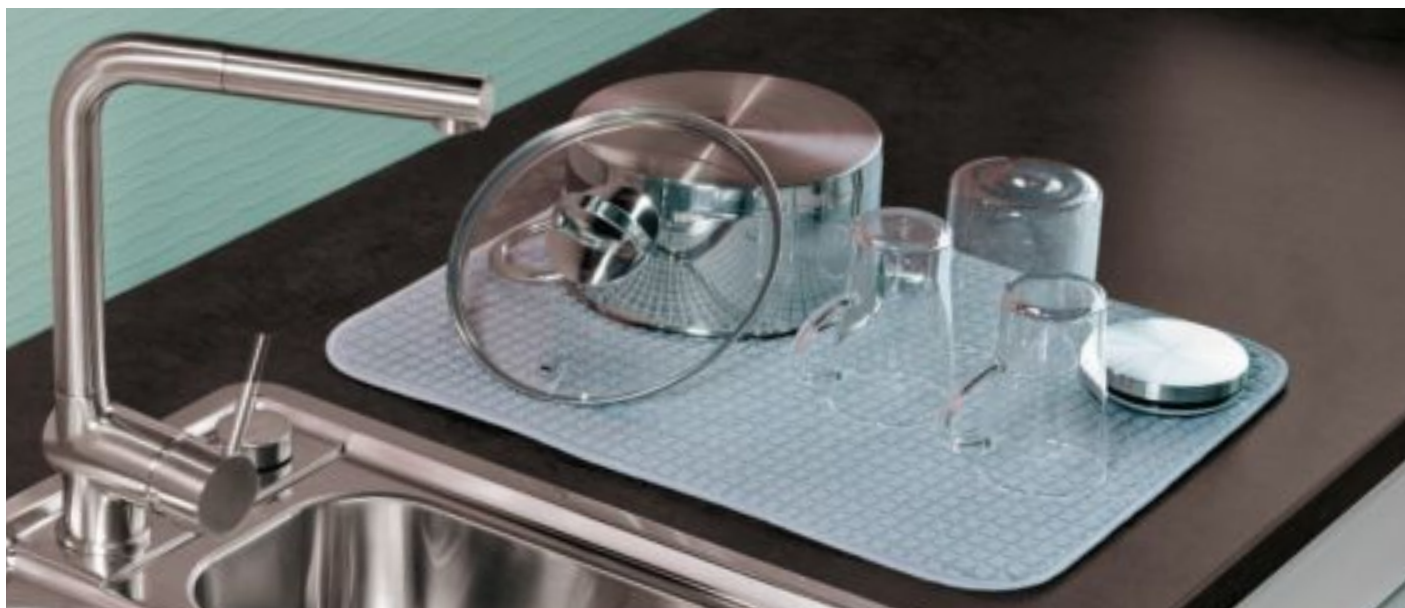

## Rapid

100 % Polyester



Hält 4 x soviel Wasser wie das eigene Volumen. Schnell trocknend. Luftzirkulation, wasserabsorbierende Schicht - 30° Waschbar - Schnelltrocknend - Fleckenresistent

Holds four times its own volume of water. Quick-drying  
Air circulation, water-absorbing layer  
30° Washable - Stain-resistant

Retient 4x son volume en eau.  
Sèche rapidement - Circulation d'air, revêtement absorbeur d'eau  
30° Lavable - Résistant aux tâches



### Abtropfmatte

Draining mat · Tapis d'évier

- 5\* 40

11641 4025457116414

Grün · Green · Vert

50 x 38 cm



### Abtropfmatte

Draining mat · Tapis d'évier

- 5\* 40

11642 4025457116421

Grau · Grey · Gris

50 x 38 cm



## Rincer

PVC · Reach-Konform

PVC · Reach-conform

PVC · Reach-conforme

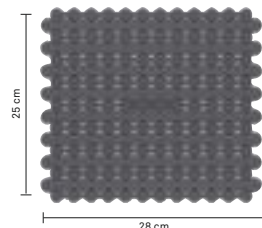

### Spülbeckeneinlage

Sink insert · Insert d'évier

1 - 25

12241 4025457122415

Hellgrau · Light grey · Gris clair

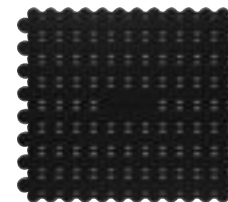

### Spülbeckeneinlage

Sink insert · Insert d'évier

1 - 25

12242 4025457122422

Schwarz · Black · Noir

## Universal-Reinigungstücher & Geschirrtücher

### Pasado

100 % Baumwolle  
100 % Cotton  
100 % Coton



3x

#### Geschirrtücher

Dish towels · Torchons de cuisine

- 12\* 48 65 x 45 cm

**15964** 4025457159640

1x Blau 2x Karo  
1x Blue 2x Checked  
1x Bleu 2x Carreau



3x

#### Geschirrtücher

Dish towels · Torchons de cuisine

- 12\* 48 65 x 45 cm

**15960** 4025457159602

1x Grün 1x Karo 1x Streifen  
1x Green 1x Checked 1x Stripe  
1x Vert 1x Carreau 1x Bande



3x

#### Geschirrtücher

Dish towels · Torchons de cuisine

- 12\* 48 65 x 45 cm

**15961** 4025457159619

1x Grau 1x Karo 1x Streifen  
1x Grey 1x Checked 1x Stripe  
1x Gris 1x Carreau 1x Bande



3x

#### Geschirrtücher

Dish towels · Torchons de cuisine

- 12\* 48 65 x 45 cm

**15963** 4025457159633

1x Rot 1x Karo 1x Streifen  
1x Red 1x Checked 1x Stripe  
1x Rouge 1x Carreau 1x Bande



3x

#### Geschirrtücher

Dish towels · Torchons de cuisine

- 12\* 48 65 x 45 cm

**15966** 4025457159664

1x Rose 1x Karo 1x Streifen  
1x Rose 1x Checked 1x Stripe  
1x Rose 1x Carreau 1x Bande



4x

#### Universal-Reinigungstücher Supor

Universal cleaning cloths

Microfibre universelle

- 6\* 54 35 x 35 cm

**11644** 4025457116445

80 % Polyester · Polyester · Polyester  
20 % Polyamid · Polyamide · Polyamide

300 gsm

2x Grün 2x Grau  
2x Green 2x Grey  
2x Vert 2x Gris



8x

#### Universal-Reinigungstücher Lou

Universal cleaning cloths

Microfibre universelle

- 6\* 48 30 x 30 cm

**11684** 4025457116841

100 % Polyester · Polyester · Polyester

200 gsm

2x Opalgrau · Opal grey · Gris opal  
2x Pastellblau · Pastel blue · Bleu pastel  
2x Pastellgrün · Pastel green · Vert pastel  
2x Pastelltürkis · Pastel turquoise ·  
Bleu turquoise



### Supor / Lou

Mikrofaser  
Microfibre  
Microfibre









# *Wunderschön harmonisch abgestimmt*

Unsere Textilien sind aus 100 % Baumwolle gefertigt, saugfähig und fusselarm. Besonderen Wert legen wir auf die Ausführung im Detail. Die Kanten sind hochwertig vernäht und eine kurze Seite ist mit einer praktischen Aufhängeschleife versehen. Die Schürze kann durch Druckknöpfe variabel eingestellt werden.

## **Wonderfully harmoniously coordinated**

Our textiles are made of 100% cotton, absorbent and with minimum lint. We attach particular value to details. The corners feature quality stitching and one short side boasts a handy hanging loop. Snap fasteners allow the apron to be adjusted.

## **Assorti avec harmonie**

Tous nos textiles sont garantis 100% Coton, absorbant et sans bouloches. Nous sommes particulièrement attentifs aux détails lors de la fabrication. Les coutures sont proposées en coins capuchon et un crochet pratique pour faciliter la suspension. Deux boutons pressions permettent de régler la hauteur du tablier.

# Carla

100 % Baumwolle, gewebt  
 100 % Cotton, woven  
 100 % Coton, tissé



1. 12274 4025457122743  
 2. 12275 4025457122750

<b>Schürze</b> · Apron · Tablier		80 x 67 cm	
-/6*/48			
<b>Topfhandschuh</b> · Oven glove · Gant		28 x 18 cm	
-/10*/160			
<b>Topflappen</b> · Oven cloth · Manique		20 x 20 cm	
-/10*/180			
<b>Geschirrtuch</b> · Dish towel · Torchon de cuisine		70 x 50 cm	
-/12*/144	190 gsm		



3. 12272 4025457122729  
 4. 12273 4025457122736

5. 12270 4025457122705  
 6. 12271 4025457122712

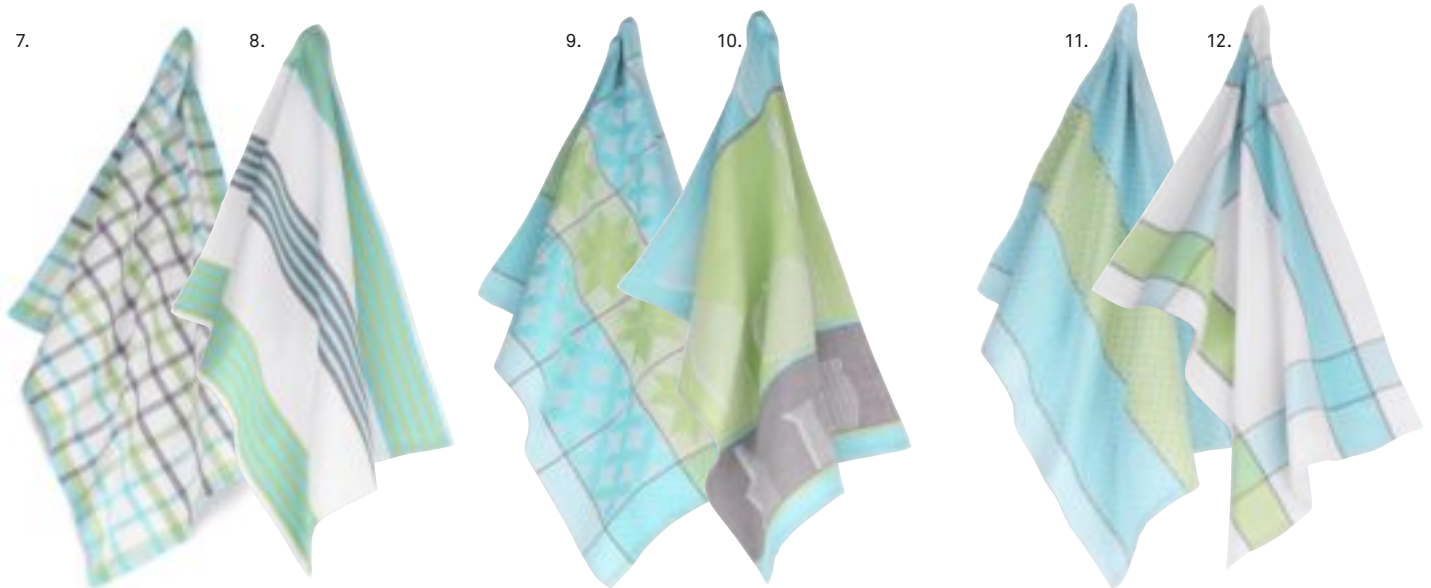

7. 12276 4025457122767  
 8. 12277 4025457122774

9. 12278 4025457122781  
 10. 12279 4025457122798

11. 12280 4025457122804  
 12. 12281 4025457122811



# Ethno

100 % Baumwolle, gewebt  
 100 % Cotton, woven  
 100 % Coton, tissé

<b>Schürze · Apron · Tablier</b>				
-/2*/48		80 x 67 cm		
<b>Topfhandschuh · Oven glove · Gant</b>				
-/4*/160		28 x 18 cm		
<b>Topflappen · Oven cloth · Manique</b>				
-/4*/180		20 x 20 cm		
<b>Geschirrtuch · Dish towel · Torchon de cuisine</b>				
-/4*/144	195 gsm	70 x 50 cm		

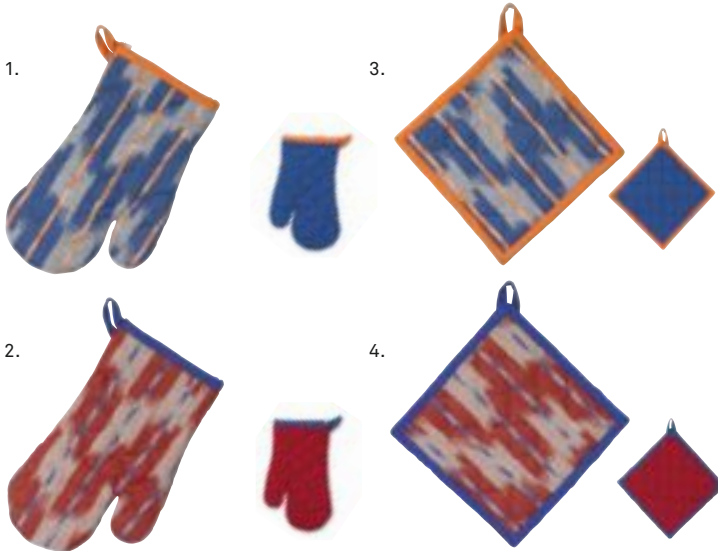

1. 12442 4025457124426  
 2. 12443 4025457124433

3. 12444 4025457124440  
 4. 12445 4025457124457



5. 12440 4025457124402  
 6. 12441 4025457124419

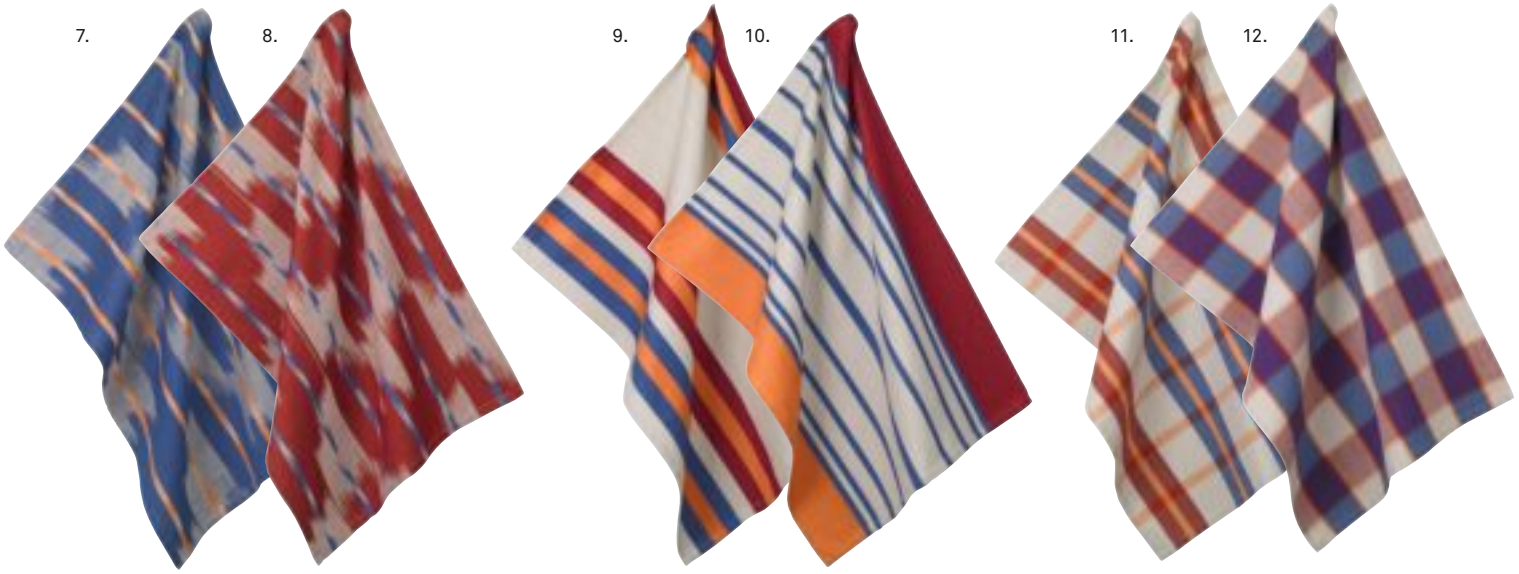

7. 12446 4025457124464  
 8. 12447 4025457124471

9. 12448 4025457124488  
 10. 12449 4025457124495

11. 12450 4025457124501  
 12. 12451 4025457124518

# Henrik

100 % Baumwolle, gewebt  
 100 % Cotton, woven  
 100 % Coton, Tissé



15108



15107



Seite · Page 122  
 Passende Tisch-Sets  
 Suitable table-sets · Set de table assortis

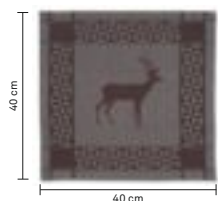

**Serviette Hirsch**

Napkin · Serviette de table

- 6\* 144

12268 4025457122682 195 gsm

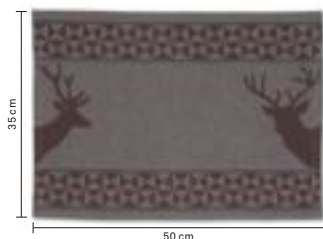

**Tisch-Set Hirsch**

Table set · Set de table

- 6\* 144

12269 4025457122699 195 gsm

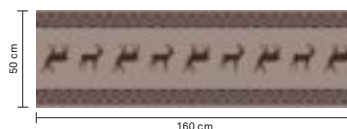

**Tischläufer Hirsch**

Table runner · Chemin de table

- 6\* 48

12267 4025457122675 195 gsm

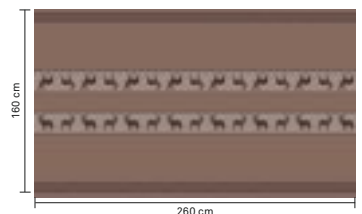

**Tischdecke Hirsch**

Tablecloth · Nappe

1 - 12

12266 4025457122668 195 gsm



# Henrik

<b>Schürze · Apron · Tablier</b>				
-/6*/48		80 x 67 cm		
<b>Topfhandschuh · Oven glove · Gant</b>				
-/10*/160		28 x 18 cm		
<b>Topflappen · Oven cloth · Manique</b>				
-/10*/180		20 x 20 cm		
<b>Geschirrtuch · Dish towel · Torchon de cuisine</b>				
-/12*/144	190 gsm		70 x 50 cm	



3.

4.

5.

6.

1. 12289 4025457122897  
2. 12290 4025457122903

3. 12288 4025457122880  
4. 12285 4025457122859

5. 12287 4025457122873  
6. 12286 4025457122866



7.

8.

9.

10.

11.

12.

7. 12292 4025457122927  
8. 12293 4025457122934

9. 12294 4025457122941  
10. 12295 4025457122958

11. 12296 4025457122965  
12. 12298 4025457122989



Halbschürze Dreieck

Waist apron · Tablier

- 6\* 48

12291 4025457122910

# Tabea

100 % Baumwolle, gewebt  
 100 % Cotton, woven  
 100 % Coton, tissé



1. 11741 4025457117411  
 2. 11742 4025457117428

<b>Schürze</b> · Apron · Tablier		80 x 67 cm	
-/6*/48			
<b>Topfhandschuh</b> · Oven glove · Gant		28 x 18 cm	
-/10*/160			
<b>Topflappen</b> · Oven cloth · Manique		20 x 20 cm	
-/10*/180			
<b>Geschirrtuch</b> · Dish towel · Torchon de cuisine		70 x 50 cm	
-/12*/144 190gsm			



3. 11737 4025457117374  
 4. 11738 4025457117381

5. 11739 4025457117398  
 6. 11740 4025457117404



7. 11730 4025457117305  
 8. 11731 4025457117312

9. 11732 4025457117329  
 10. 11733 4025457117336

11. 11734 4025457117343

12. 11736 4025457117367

# Citrus

100 % Baumwolle, gewebt  
 100 % Cotton, woven  
 100 % Coton, tissé



**12464**

40 cm

40 cm

**Serviette**  
 Napkin · Serviette de table

-	6*	144
<b>12464</b>	4025457124648	
<b>12465</b>	4025457124655	
195 gsm		

**12463**

35 cm

50 cm

**Tisch-Set**  
 Table set · Set de table

-	6*	144
<b>12462</b>	4025457124624	
<b>12463</b>	4025457124631	
195 gsm		

**12460**

70 cm

50 cm

**Geschirrtuch**  
 Dish towel · Torchon de cuisine

-	4*	144	
<b>12460</b>	4025457124600		
<b>12461</b>	4025457124617		
195 gsm			



# Tisch-Set & Untersetzer



## Kimara

Kunstleder 2 mm stark  
Leatherrette, 2 mm thick  
Similicuir, 2 mm épais

**Tisch-Set**  
Placemats · Set de table

- 12\* 48

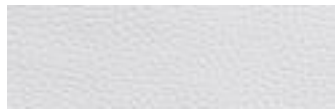
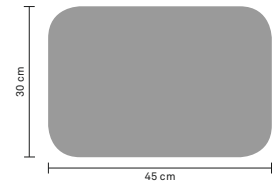

**Weiß** · White · Blanc

12095 4025457120954



**Grau** · Grey · Gris

12096 4025457120961



**Schwarz** · Black · Noir

12098 4025457120985



**Braun** · Brown · Brun

12097 4025457120978



**Rosa** · Pink · Rosé

12312 4025457123122



**Mintgrün** · Mint green · Menthe

12313 4025457123139



**Hellblau** · Light blue · Bleu clair

12311 4025457123115



**Dunkelgrau** · Dark grey · Gris foncé

12310 4025457123108



## Unter-setzer

Trivet · Dessous-de-plat

- 6\* 30

4-teilig · 4 pieces · 4 pièces

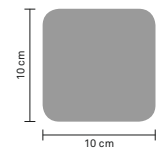

4x

**Weiß** · White · Blanc

12090 4025457120909



4x

**Grau** · Grey · Gris

12091 4025457120916



4x

**Schwarz** · Black · Noir

12093 4025457120930



4x

**Braun** · Brown · Brun

12092 4025457120923



# Tisch-Set & Unter-setzer

## Alia

100 % Filz · 4 mm stark  
 100 % Felt · 4 mm thick  
 100 % Feutre · 4 mm épais

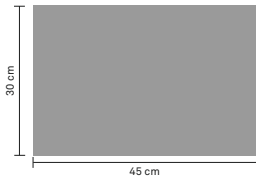

**Tisch-Set**  
 Placemat · Set de table

- 12\* 120



**Beige** · Beige · Beige

12325 4025457123252



**Hellgrau** · Light grey · Gris clair

12321 4025457123214



**Dunkelgrau** · Dark grey · Gris foncé

12323 4025457123238



**Braun** · Brown · Brun

12320 4025457123207



**Orange** · Orange · Orange

12326 4025457123269

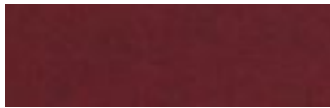

**Altrot** · Dark red · Rouge ancien

12324 4025457123245



**Petrol** · Teal blue · Petrol

12322 4025457123221



**Grün** · Green · Vert

11804 4025457118043

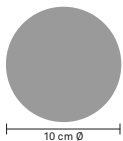

**Unter-setzer**

Trivet · Dessous-de-plat

- 6\* 120

4-teilig · 4 pieces · 4 pièces



**Beige** · Beige · Beige

12335 4025457123351



**Hellgrau** · Light grey · Gris clair

12331 4025457123313



**Dunkelgrau** · Dark grey · Gris foncé

12333 4025457123337



**Braun** · Brown · Brun

12330 4025457123306



**Orange** · Orange · Orange

12336 4025457123368



**Altrot** · Dark red · Rouge ancien

12334 4025457123344



**Petrol** · Teal blue · Petrol

12332 4025457123320



**Grün** · Green · Vert

11824 4025457118241

# Tisch-Set



## Nicoletta

85 % PVC · 15 % Polyester  
85 % PVC · 15 % Polyester  
85 % PVC · 15 % Polyester

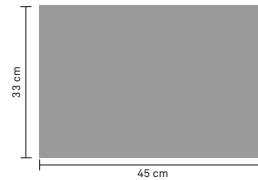

**Tisch-Set**  
Placemats · Set de table

- 12\* 144



**Creme** · Cream · Crème

12035 4025457120350



**Weiß/Schwarz** · White/Black · Blanc/Noir

12037 4025457120374



**Rot** · Red · Rouge

12043 4025457120435



**Goldbraun** · Golden brown · Brun doré

12044 4025457120442



**Grün** · Green · Vert

12039 4025457120398



**Dunkelgrün** · Dark green · Vert foncé

12040 4025457120404



**Braun** · Brown · Brun

12046 4025457120466



**Anthrazit** · Anthracite · Anthracite

12045 4025457120459



**Blau** · Blue · Bleu

12041 4025457120411



**Aubergine** · Aubergine · Aubergine

12042 4025457120428



## Plato

70 % PVC · 30 % Polyester  
70 % PVC · 30 % Polyester  
70 % PVC · 30 % Polyester

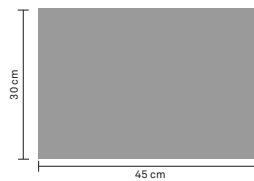

**Tisch-Set**  
Placemats · Set de table

- 12\* 96



**Creme** · Cream · Crème

15634 4025457156342



**Weiß** · White · Blanc

15633 4025457156335



**Hellgrau** · Light grey · Gris clair

11374 4025457113741



**Grau** · Grey · Gris

15641 4025457156410



**Hellbraun/Schwarz**

Light brown/Black · Brun clair/Noir

15638 4025457156380



**Schwarz/Weiß**

Black/White · Noir/Blanc

15644 4025457156441

# Tisch-Set

## Glitter

PET-Kunststoff  
PET plastic  
PET-plastique

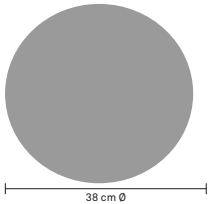

**Tisch-Set**  
Placemats · Set de table  
- 12\* 144

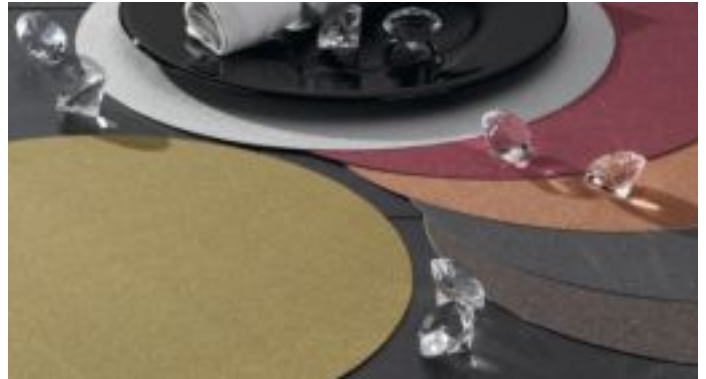

**Anthrazit** · Dark grey · Gris foncé  
12380 4025457123801



**Silber** · Silver · Argent  
12381 4025457123818



**Gold** · Gold · Or  
12382 4025457123825



**Braun** · Brown · Brun  
12383 4025457123832



**Rot** · Red · Rouge  
12384 4025457123849



**Kupfer** · Copper · Cuivré  
12385 4025457123856

## Kimya

PP-Kunststoff, 2 mm stark  
PP plastic, 2 mm thick  
PP plastique, 2 mm épais

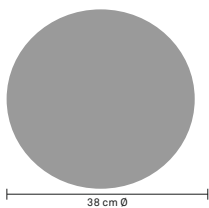

**Tisch-Set**  
Placemats · Set de table  
- 12\* 144

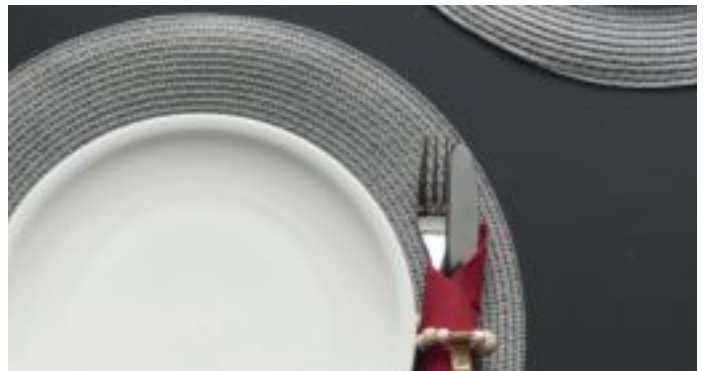

**Creme** · Cream · Crème  
12339 4025457123399



**Hellgrau** · Light grey · Gris clair  
12340 4025457123405



**Schwarz** · Black · Noir  
12338 4025457123382



**Grau** · Grey · Gris  
12337 4025457123375

# Tisch-Set



## Picture

PP-Kunststoff  
PP plastic  
PP-plastique

### Tisch-Set

Placemats · Set de table

- 12\* 144

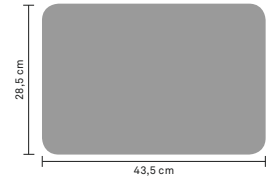

Triangle

15107 4025457151071



Hirsch

15108 4025457151088



Cups black

11750 4025457117503



Coffee cups

15029 4025457150296



Mohn

15105 4025457151057



Gerbera

15056 4025457150562



Margarite

15037 4025457150371



Coffee beans

15077 4025457150777

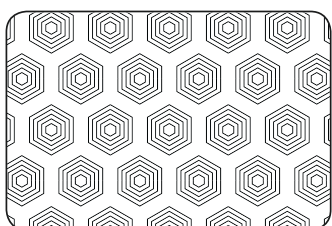

Diamond

15028 4025457150289

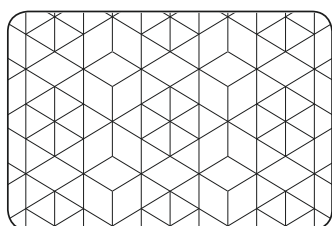

Graphik

15026 4025457150265

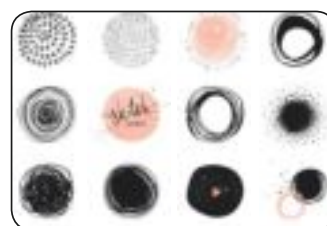

Circle

15025 4025457150258

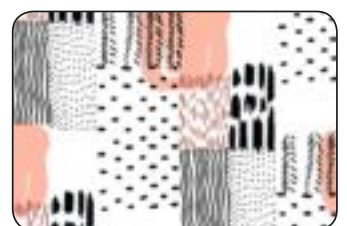

Free style

15030 4025457150302



# Tisch-Set

## Uni

100 % PVC  
100 % PVC  
100 % PVC

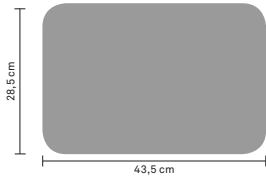

**Tisch-Set**  
Placemats · Set de table  
- 12\* 144



**Gelb** · Yellow · Jaune  
15002 4025457150029



**Orange** · Orange · Orange  
15003 4025457150036



**Rot** · Red · Rouge  
15001 4025457150012



**Altrot** · Dark red · Rouge ancien  
15014 4025457150142



**Lemongrün** · Lemon green · Citron vert  
15004 4025457150043



**Schwarz** · Black · Noir  
15007 4025457150074



**Dunkelblau** · Dark blue · Bleu foncé  
15011 4025457150111



**Pastellblau** · Pastel blue · Bleu pastel  
15019 4025457150197

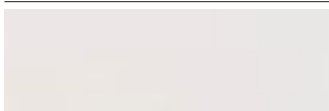

**Weiß** · White · Blanc  
15006 4025457150067

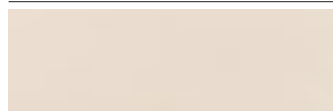

**Beige** · Beige · Beige  
15008 4025457150081



**Taupe** · Taupe · Taupe  
15018 4025457150180

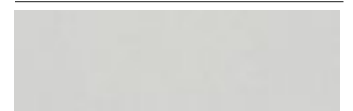

**Grau** · Grey · Gris  
15017 4025457150173

## Calina

PP-Kunststoff  
PP plastic  
PP-plastique

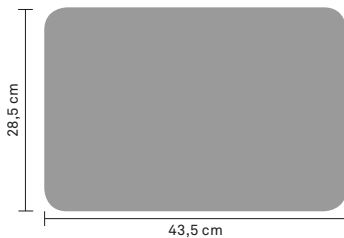

**Tisch-Set**  
Placemats · Set de table  
- 12\* 144



**Weiß** · White · Blanc  
11632 4025457116322



**Grau** · Grey · Gris  
11633 4025457116339



**Rot** · Red · Rouge  
11634 4025457116346



**Taupe** · Taupe · Taupe  
11639 4025457116391



**Altrot** · Dark red · Rouge ancien  
11638 4025457116384



**Grün** · Green · Vert  
11635 4025457116353

# Wanduhr

PS-Kunststoff · Batteriebetrieben · Ohne Batterie  
 PS plastic · Battery-operated · Without battery  
 PS-plastique · Fonctionne avec pile · Sans pile

1xAA 1,5V



**Wanduhr Paris**

Wall clock · Horloge murale

1 - 20

**17161** 4025457171611

Weiß · White · Blanc



**Wanduhr Kopenhagen**

Wall clock · Horloge murale

1 - 20

**22731** 4025457227318

Petrol · Teal blue · Petrol



**Wanduhr Turin**

Wall clock · Horloge murale

1 - 20

**22734** 4025457227349

Mintgrün · Mint green · Vert menthe



**Wanduhr Florenz**

Wall clock · Horloge murale

1 - 20

**22736** 4025457227363

Grau · Grey · Gris



**Wanduhr Stockholm**

Wall clock · Horloge murale

1 - 20

**22732** 4025457227325

Cashmerebraun  
 Cashmere brown · Cashmere maron



**Wanduhr Mailand**

Wall clock · Horloge murale

1 - 20

**22733** 4025457227332

Perlosa · Perly pink · Rose perlé



**Wanduhr Berlin**

Wall clock · Horloge murale

1 - 20

**17162** 4025457171628

Schwarz · Black · Noir

# Schirmständer



**Schirmständer Graphit**

Umbrella stand · Porte-parapluies

1 - 2

**21364** 4025457213649

Metall farbig beschichtet  
 Colour-coated metal  
 Métal revêtement couleur

Schwarz · Black · Noir



**Schirmständer Linda**

Umbrella stand · Porte-parapluies

1 - 2

**21365** 4025457213656

Metall farbig beschichtet  
 Colour-coated metal  
 Métal revêtement couleur

Weiß · White · Blanc



**Schirmständer Swing**

Umbrella stand · Porte-parapluies

1 - 2

**18031** 4025457180316

Edelstahl · Stainless steel · Inox

Matt · Matt · Mat

Edelstahl  
 Stainless steel · Inox

The image shows two modern, cylindrical trash cans on a light-colored wooden floor. The trash can on the left is a light blue color with a black base and a silver handle. The trash can on the right is a silver color with a black base and a silver handle. The background is a blurred indoor setting with a white wall and a wooden cabinet.

# *Gut gelaunte Truppe*

Good-humoured chums

La cavalerie colorée



# Treteimer Davino

Edelstahl · **Silent Close-System**  
 Stainless steel · **Silent Close-System**  
 Inox · **Silent Close-System**



Edelstahl  
 Stainless steel · Inox

- Platzsparend - dank der geraden Form passt Davino ganz eng an die Wand und in jede Ecke
- Geräuschloser Deckelverschluss durch das Silent Close-System
- Tragegriff an der Rückseite
- Loch im Inneneimer zur Fixierung des Müllbeutels
- Space-saving - Davino fits closely against the wall, thanks to its straight shape
- Silent lid closing, thanks to the Silent Close-System
- Carry handle on the rear
- Hole in the inner bin to fix the waste bag
- Sa forme rectangulaire permet un gain de place
- Fermeture silencieuse avec Système Silent-Close
- Poignée de portage

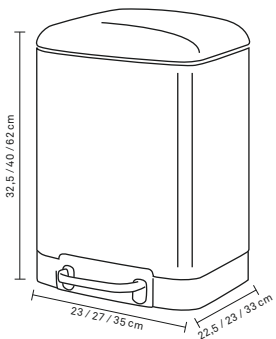

Treteimer		Dust bin · Poubelle	
1	- 4	📦	6 L
<b>22998</b>	4025457229985		
1	- 4	📦	12 L
<b>10902</b>	4025457109027		
1	- 2	📦	30 L
<b>10903</b>	4025457109034		
Matt · Matt · Mat			
Edelstahl · Stainless steel · Inox			

Treteimer		Dust bin · Poubelle	
1	- 4	📦	6 L
<b>22996</b>	4025457229961		
1	- 4	📦	12 L
<b>10904</b>	4025457109041		
1	- 2	📦	30 L
<b>10905</b>	4025457109058		
Glänzend · Bright · Brillant			
Metall farbig beschichtet Colour-coated metal Métal revêtement couleur			
Weiß · White · Blanc			

Treteimer		Dust bin · Poubelle	
1	- 4	📦	6 L
<b>22997</b>	4025457229978		
1	- 4	📦	12 L
<b>10906</b>	4025457109065		
1	- 2	📦	30 L
<b>10907</b>	4025457109072		
Glänzend · Bright · Brillant			
Metall farbig beschichtet Colour-coated metal Métal revêtement couleur			
Hellgrau · Light grey · Gris clair			





# Treteimer



<b>Treteimer</b>	
Dust bin · Poubelle	
1	- 4
<b>10931</b>	4025457109317
Schwarz · Black · Noir	

**Malta 12 L**  
 Metall farbig beschichtet · Matt · **Silent Close-System**  
 Colour-coated metal · Matt · **Silent Close-System**  
 Métal revêtement couleur · Mat · **Silent Close-System**



<b>Beige</b> · Beige · Beige	
1	- 4
<b>10932</b>	4025457109324



<b>Weiß</b> · White · Blanc	
1	- 4
<b>10929</b>	4025457109294



<b>Hellgrau</b> · Light grey · Gris clair	
1	- 4
<b>10933</b>	4025457109331



<b>Dunkelgrau</b> · Dark grey · Gris foncé	
1	- 4
<b>10942</b>	4025457109423



Edelstahl  
Stainless steel · Inox

<b>Treteimer Mala</b>	
Dust bin · Poubelle	
1	- 4
<b>10927</b>	4025457109270
Edelstahl · Stainless steel · Inox	
Matt · Matt · Mat	



Edelstahl  
Stainless steel · Inox

<b>Treteimer Nila</b>	
Dust bin · Poubelle	
1	- 4
<b>10925</b>	4025457109256
Edelstahl · Stainless steel · Inox	
Glänzend · Bright · Brillant	

## Edelstahl 12 L

**Silent Close-System**  
**Silent Close-System**  
**Silent Close-System**





# *Point of Sale*

Eine perfekte Markenpräsentation am POS ist der Schlüssel zum Erfolg. Mit der Marke Kela bieten wir ein breites und vielfältiges Produkt-Spektrum für die Bereiche Tisch, Küche und Bad. Mit der passenden Produktpräsentation bieten wir Ihren Kunden eine einladende Shopatmosphäre, die sowohl die Produkte im richtigen Licht zeigt als auch den Abverkauf und somit Ihren Umsatz steigert.

## *Unser Know-How*

Wir unterstützen Sie mit einer professionellen Flächen- und Sortimentsplanung. Am Ende profitieren Sie von einer attraktiven Kela-Verkaufsfläche, die den Ansprüchen Ihrer Kunden gerecht wird und immer wieder neue Kaufimpulse setzt.

# Der Schlüssel zum Erfolg

*The key to success*

*La clé du succès*

Perfect presentation of the brand at the POS is the key to success. The Kela brand offers a broad-based and varied product range for the table, kitchen and bathroom. Coordinated product presentation enables us to offer your customers an inviting store atmosphere, which showcases our products in the best light and hence generates sales and thus increases your turnover.

## ***Our knowledge and expertise***

We can support you with professional shop floor and range planning. At the end, you will benefit from an attractive Kela sales area that will meet your customers' demands and stimulate purchases time and time again.

Pour booster les ventes , rien de mieux qu'une présentation parfaite de la marque sur le point de vente. Avec la marque Kela, nous vous proposons un assortiment très large et varié , dans le domaine de la Table, de la Cuisine et du Bain.

Une présentation des produits adéquate donnera une atmosphère unique , qui les mettra en valeur et invitera vos clients à les découvrir plus facilement, et permettra ainsi une hausse sensible de vos ventes.

## ***Notre Savoir Faire***

Nos professionnels vous accompagnent par le biais d'une proposition de mise en place des articles sur votre point de vente , le but étant de vous faire profiter d'une présentation attractive qui provoquera des achats d'impulsion à vos clients.







# Perfekte Lösungen

*Perfect solutions*

*Des solutions parfaites*

Wir investieren viel Zeit und Energie für ein optimales, markengerechtes Verpackungsdesign unserer Produkte, das am POS für Aufmerksamkeit sorgt, wichtige Informationen transportiert, eine klare Auskunft über den Inhalt gibt und last but not least zum Kauf anregt.

We are investing a lot of time and energy in developing an optimum packaging design for our products to match the brand, which will attract attention at the POS, convey key information, provide clear information about the content and, last but not least, generate sales.

Nous investissons beaucoup de temps et d'énergie afin de proposer un packaging de nos produits, attrayant, design et adapté au marché.

Ce packaging attire l'œil sur le point de vente et apporte des informations importantes, une réponse claire du contenu et in fine, stimule l'envie d'achat.

Aufmerksamkeitsstarke Deko-Pakete stehen im Rahmen von Verkaufsaktionen zur Verfügung.

Eye-catching decorative packages will be available for sales promotions.

Pour nos actions promotionnelles, nous mettons à disposition des packaging déco spécifiques pour de nombreuses promotions.

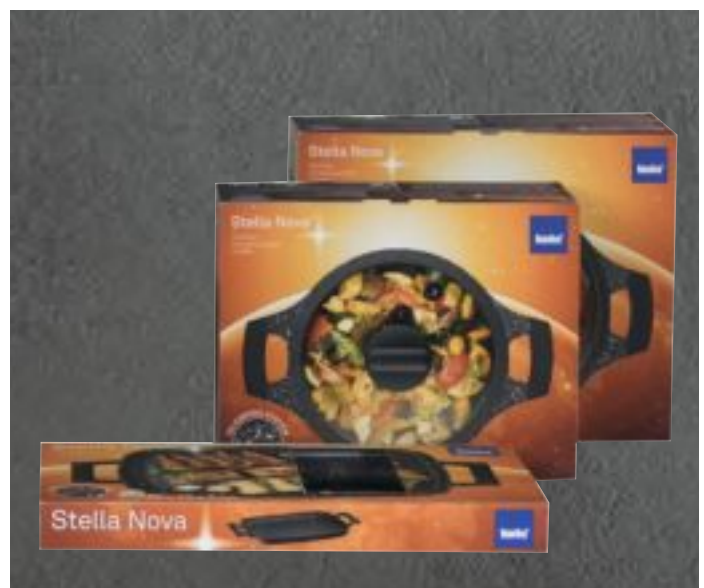





Attraktiv und abverkaufsstark.  
Für viele Produkte bietet Kela übersichtliche Einzelpräsentier, die den Anforderungen der Produkte gerecht werden und im Verkaufsräum die Aufmerksamkeit der Konsumenten auf sich ziehen.

Attractive and sales-promoting  
Kela also offers clearly designed single product displays for many products, which meet the needs of the products at the same time as drawing consumers' attention to them on the sales floor.

Attrayant et vendeur  
Pour de nombreux produits, Kela propose des présentoirs individuels, mettant en valeur les produits afin d'attirer l'œil du consommateur.

## *b2b.kela.de*

Wir möchten, dass Sie sich bei Kela rundum wohlfühlen. Auf unserem neu eingerichteten B2B Online-Portal informieren wir Sie über aktuelle Themen und über die neuesten Aktionen.

Mit Ihrem persönlichen B2B Account können Sie Bestellungen tätigen, sich jederzeit und überall über den aktuellen Stand Ihrer Aufträge informieren und Ihre Kundendaten einsehen.

Wir freuen uns auf Ihren Online-Besuch.

We want you to feel completely at home around Kela. We also use our recently set up B2B online portal to inform you about current topics and the latest campaigns and promotions. Your personal B2B account lets you find out the current status of your orders, view your customer data or place orders at any time and any place. We look forward to your visit online.

Notre but est que vous vous sentiez bien avec Kela. Notre nouveau portail online B2B vous informe sur nos dernières thématiques et nouveautés ainsi que sur les actions en cours.

Grâce à votre compte personnel B2B, vous pouvez à tous moments et ou que vous soyez être informé sur l'état de votre commande en cours, vos données personnelles ou passer commande directement.

Nous nous réjouissons de votre visite Online.

# Index

Sie suchen einen bestimmte Artikelnummer? Hier finden Sie die passende Seitenzahl  
 Are you looking for a specific item number? Here you will find the matching page number

Artikel	Page	10904	126	11208	50	11495	63	11685	34	11901	72	12027	57	12153	69
10030	45	10905	126	11212	47	11497	70	11686	34	11906	54	12028	73	12154	69
10031	43	10906	126	11213	47	11498	70	11687	34	11907	54	12035	120	12155	69
10032	43	10907	126	11214	47	11499	70	11688	34	11920	98	12037	120	12160	40
10033	43	10925	127	11217	45	11519	106	11697	66	11921	98	12039	120	12161	40
10035	43	10927	127	11218	50	11520	106	11698	55	11925	98	12040	120	12162	40
10036	43	10929	127	11219	50	11537	106	11699	55	11926	98	12041	120	12163	40
10037	43	10931	127	11220	50	11549	12	11715	44	11927	98	12042	120	12164	70
10038	43	10932	127	11226	40	11550	12	11717	44	11940	15	12043	120	12165	70
10584	62	10933	127	11227	40	11552	12	11718	44	11941	15	12044	120	12170	53
10585	62	10942	127	11228	40	11553	12	11719	44	11942	15	12045	120	12172	53
10586	62	10947	34	11229	40	11554	12	11720	51	11943	15	12046	120	12173	53
10590	62	10948	34	11230	40	11555	12	11721	51	11947	15, 29	12047	57	12200	27
10591	62	10953	27	11231	40	11559	11	11723	51	11948	15	12048	58	12201	27
10592	62	10955	23	11286	49	11560	11	11730	116	11949	15	12050	99	12202	27
10600	62	10956	23	11287	49	11561	11	11731	116	11955	96	12051	99	12203	27
10601	62	10957	23	11288	49	11563	12	11732	116	11956	96	12052	99	12204	27
10746	74	10958	23	11304	47	11564	11	11733	116	11957	96	12053	99	12205	27
10747	74	10959	23	11348	48	11567	11	11734	116	11958	96	12060	100	12206	27
10752	74	10960	23	11349	48	11568	11	11736	116	11965	104	12061	100	12207	27
10758	74	10961	23	11355	65	11616	18	11737	116	11966	104	12062	100	12215	9
10759	34	10962	23	11356	65	11617	18	11738	116	11967	104	12063	100	12216	9
10763	34	10963	23	11374	120	11618	71	11739	116	11968	104	12064	102	12217	9
10765	96	10964	23	11375	50	11619	71	11740	116	11969	104	12066	102	12218	9
10766	96	10965	24	11380	106	11632	123	11741	116	11970	104	12067	102	12219	9
10767	96	10966	24	11381	106	11633	123	11742	116	11975	55	12080	107	12220	9
10768	96	10968	24, 86	11382	106	11634	123	11750	122	11976	55	12081	107	12235	73
10769	96	10969	25	11383	106	11635	123	11781	42	11977	55	12084	99	12238	103
10775	86	10991	24	11384	106	11638	123	11782	42	11978	55	12085	99	12241	108
10780	52	10992	25	11389	105	11639	123	11783	42	11980	55	12086	99	12242	108
10781	52	10994	24	11390	105	11641	108	11784	42	11981	55	12087	99	12255	71
10785	52	10995	30	11397	68	11642	108	11785	58	11985	55	12088	99	12260	74
10807	64	10996	30	11398	68	11644	109	11786	71	11986	55	12089	99	12261	74
10808	64	11074	54	11420	59	11647	107	11787	71	11987	55	12090	118	12266	114
10826	34	11130	21	11421	59	11648	107	11788	71	11988	55	12091	118	12267	114
10835	62	11131	21	11422	59	11650	31	11804	119	11999	66	12092	118	12268	114
10836	62	11132	21	11440	30	11651	73	11824	119	12006	58	12093	118	12269	114
10837	67	11145	21	11441	30	11652	31	11841	100	12007	56	12095	118	12270	112
10838	67	11146	21	11442	30	11655	66	11848	73	12008	56	12096	118	12271	112
10848	63	11147	21	11444	72	11656	66	11849	73	12009	56	12097	118	12272	112
10849	63	11165	101	11447	72	11657	66	11860	35	12010	57	12098	118	12273	112
10851	63	11167	101	11448	72	11658	66	11861	35	12011	106	12102	54	12274	112
10852	63	11168	101	11449	72	11659	107	11862	35	12012	106	12103	54	12275	112
10866	50	11176	101	11450	72	11664	93	11863	35	12013	106	12104	97	12276	112
10870	30	11177	101	11456	67	11665	71	11864	35	12014	56	12105	97	12277	112
10871	30	11190	101	11457	65	11668	107	11865	35	12020	57	12106	97	12278	112
10872	30	11191	101	11458	65	11670	24	11870	56	12021	47	12107	97	12279	112
10873	30	11198	103	11466	73	11673	24	11871	56	12022	44	12108	97	12280	112
10900	63	11200	103	11467	47	11674	24	11872	56	12023	44	12109	97	12281	112
10901	63	11201	103	11468	43	11675	24	11873	56	12024	57	12150	69	12285	115
10902	126	11203	103	11475	72	11682	56	11874	56	12025	57	12151	69	12286	115
10903	126	11206	52	11476	31	11684	109	11900	72	12026	57	12152	69	12287	115



# Index

Sie suchen einen bestimmte Artikelnummer? Hier finden Sie die passende Seitenzahl  
 Are you looking for a specific item number? Here you will find the matching page number

12288	115	12412	64	15008	123	16567	82	19009	39	22734	124	<b>66664</b>	78
12289	115	12415	68	15011	123	16571	82	19010	39	22736	124	66665	78
12290	115	12416	68	15014	123	16580	82, 91	19012	39	22996	126	66667	77
12291	115	12417	68	15017	123	16581	82, 91	19013	39	22997	126	<b>67403</b>	89
12292	115	12418	68	15018	123	16635	87	19014	39	22998	126	67404	89
12293	115	12420	88	15019	123	16639	87	19016	39	23331	41	67405	89
12294	115	12421	88	15025	122	16640	84	19017	39	23332	41	67406	89
12295	115	12422	88	15026	122	16641	84	19019	39	23333	41	67450	89
12296	115	12423	88	15028	122	16642	86	19020	39	23335	41	67451	89
12298	115	12425	88	15029	122	16643	86	19022	39	23338	41	67837	89
12300	57	12426	88	15030	122	16644	84	19024	38	23341	41	67838	89
12305	19	12430	17	15037	122	16647	85	19027	39	23344	41	<b>77033</b>	77
12306	19	12431	17	15056	122	16648	85	19028	38	23347	41	77080	74
12310	118	12432	17	15077	122	16650	85	19029	39	23349	41	77085	74
12311	118	12433	17	15105	122	16660	81	19032	39	23354	41	77160	29
12312	118	12434	17	15107	122	16661	81	19033	39	23355	41	77747	29
12313	118	12440	113	15108	122	16662	81	19038	39	49552	72	77905	29
12320	119	12441	113	15150	11	16663	81	19039	39	49553	72	77924	90
12321	119	12442	113	15151	11	16918	103	19043	66	49880	72	77937	77
12322	119	12443	113	15152	12	16919	103	19045	52	60127	92	77943	29
12323	119	12444	113	15153	12	16920	103	19050	66	60170	92	<b>79164</b>	90
12324	119	12445	113	15154	11	16922	67	19051	66	61000	83	79167	91
12325	119	12446	113	15155	11	16940	67	19052	66	61201	83	79168	90
12326	119	12447	113	15156	11	16941	67	19054	54	61203	87	79169	90
12330	119	12448	113	15157	12, 29	16945	52	19055	54	61303	83	79170	90
12331	119	12449	113	15314	66	<b>17116</b>	31	19056	54	61305	83	79171	90
12332	119	12450	113	15315	46	17161	124	19058	54	61306	83	79184	90
12333	119	12451	113	15326	39	17162	124	19061	38	63018	92	79185	90
12334	119	12460	117	15365	50	17253	41	19062	39	63040	92	79186	91
12335	119	12461	117	15474	13	17300	41	19065	50	63054	92	79194	91
12336	119	12462	117	15475	13	17302	50	19087	45	63067	92	79312	90
12337	121	12463	117	15476	13	17304	41	19088	45	63085	92	79313	90
12338	121	12464	117	15633	120	17550	73	19092	73	64002	77	79314	91
12339	121	12465	117	15634	120	17580	73	19099	47	64010	77		
12340	121	12480	33	15638	120	17582	103	19123	45	65147	93		
12350	104	12481	33	15641	120	17600	72	19135	39	65149	93		
12351	104	12482	33	15644	120	17651	74	19139	38	66000	93		
12352	104	12483	33	15715	48	17867	98	19140	38	66163	93		
12353	104	12484	32	15716	48	17868	98	19170	52	66164	93		
12354	104	12485	32	15727	53	17869	98	19200	52	66386	87		
12355	104	12486	32	15740	53	17870	98	19210	100	66470	85		
12380	121	12487	32	15741	53	17906	52	19219	44	66490	76		
12381	121	12500	79	15746	53	17908	52	19243	73	66493	76		
12382	121	12501	79	15931	39	<b>18031</b>	124	19245	73	66496	77		
12383	121	12502	79	15960	109	<b>19000</b>	39	19246	73	66510	87		
12384	121	12503	79	15961	109	19001	38	19248	107	66513	87		
12385	121	<b>15001</b>	123	15963	109	19002	38	<b>21364</b>	124	66573	83		
12400	28	15002	123	15964	109	19003	38	21365	124	66575	83		
12401	28	15003	123	15966	109	19004	38	<b>22001</b>	107	66582	83		
12402	28	15004	123	<b>16370</b>	13	19005	38	22731	124	66595	92		
12410	64	15006	123	16560	82	19006	38	22732	124	66661	76		
12411	64	15007	123	16564	82	19007	38	22733	124	66663	76		

## Allgemeine Verkaufs- und Lieferbedingungen der Keck & Lang GmbH

Die Angebote in diesem Katalog richten sich ausschließlich an Unternehmer, Händler oder Gewerbetreibende, die bei Abschluss eines Kaufs in Ausübung ihrer gewerblichen oder selbständigen Tätigkeit handeln, nicht an Verbraucher i.S.d. § 13 BGB. Eine Weiterreichung dieses Katalogs an Verbraucher ist untersagt.

Ein Vertragsschluss erfolgt ausschließlich auf der Grundlage unserer AGB, welche wir Ihnen auf Wunsch gerne zur Verfügung stellen und welche Sie auch auf unserer Homepage unter <https://www.kela.de/html/de/document-1-agb.html.html> einsehen können.

Die Produktabbildungen und Zeichnungen in diesem Katalog unterliegen Urheber- und Verwertungsrechten, welche ausschließlich bei uns liegen. Jede nicht von uns autorisierte Nutzung und Vervielfältigung ist untersagt und wird von uns verfolgt.

## General terms and conditions of sale and delivery of Keck & Lang GmbH

The offers in this catalogue are solely geared to entrepreneurs, dealers or traders who, in the event of a purchase, exercise their commercial or self-employed work, and not to consumers within the meaning of Section 13 of the German Civil Code (BGB). Passing this catalogue to consumers is prohibited.

A contract will only be concluded on the basis of our Terms and Conditions of Sale, which we would be pleased to provide you with on request and which you can view on our website at <https://www.kela.de/html/de/document-1-agb.html.html>

The product illustrations and drawings in this catalogue are subject to copyright and exploitation rights that we exclusively own. Any use and reproduction not authorised by us is prohibited and will be prosecuted by us.

## Conditions générales de vente et de livraison de la société Keck & Lang GmbH

Les offres de ce catalogue s'adressent uniquement aux professionnels, revendeurs et commerçants qui de part leur activité en font un usage professionnel, et non au consommateur final i.S.d. § 13 BGB.

Il est formellement interdit de transmettre ce catalogue à un consommateur final. Cet accord se base sur nos Conditions Générales de Vente, que nous mettons à votre disposition à votre demande et que vous pouvez consulter sur notre page Web <https://www.kela.de/html/de/document-1-agb.html.html>

Les photographies, illustrations et descriptions sont la propriétés de Kela et sont soumis à autorisations de droit d'exploitation. Tout usage ou duplication sans autorisation est interdit et sera poursuivi devant les tribunaux.

**Blister mit Eurolochung**Blister with Euro hole  
Blister avec accrochage européen**Geschenkkarton**Gift box  
Boîte cadeau**Banderole / Color Label**Package band  
Banderole**Display****1 - 1**

VE / IK / UK

**Verkaufseinheit/Innenkarton/Umkarton**Sales unit/Inner box/Master box  
Conditionnement/Cros conditionnement**21540****Artikelnummer**Item number  
Référence**4025457215407****EAN-Nummer**EAN-Code  
Gen-Code**Backofen**Oven  
Four**Elektroherd**Electric cooker  
cuisinière électrique**Keramikfeld**Ceramic hob  
Domaine de la céramique**Gasherd**Gas cooker  
Cuisinière à gaz**Radiant**Radiant heater  
Plaque céramique**Induktion**Induction  
Induction**Spülmaschine**Dishwasher  
Lave-vaisselle**Materialstärke**Material thickness  
Épaisseur du matériau**PFOA Frei**PFOA Free  
Sans PFOA**Washbar**Washable  
Lavable**Nicht bleichen**Do not bleach  
Ne pas blanchir**Trockner geeignet**Dryer suitable  
Sèche linge**Bügeln**Iron  
Fer à repasser**Keine chemische Reinigung**No chemical cleaning  
Nettoyage à sec

